

STATE OF UTAH
DEPARTMENT OF ENVIRONMENTAL QUALITY
DIVISION OF WATER QUALITY
WATER QUALITY BOARD
P.O. BOX 144870
SALT LAKE CITY, UTAH 84114-4870

**Ground Water Discharge Permit
Permit No. UGW270014**

In compliance with the provisions of the Utah Water Quality Act, Title 19, Chapter 5, Utah Code Annotated 1953, as amended, the Act,

Advanced Clean Energy Storage I, LLC
3165 East Millrock Drive, Suite 330
Holladay, UT 84121

hereafter referred to as the Permittee, is granted a Ground Water Discharge Permit for a cooling and blowdown water pond in Millard County, Utah. The Advanced Clean Energy Storage (ACES) hydrogen cracking facility cooling and blowdown water pond is located at Latitude 39.483° North, Longitude -112.601° West on the following tracts of land (Salt Lake Base and Meridian):

Name	Section	Township	Range	Allotment
Cooling and Blowdown water pond	26	15 South	7 West	South 1/2

This permit is based on representation made by the Permittee and other information in the administrative record. It is the responsibility of the Permittee to read and understand all provisions of this permit.

The facility shall be constructed and operated in accordance with conditions set forth in the permit and the Utah Administrative Rules for Ground Water Quality Protection (UAC R317-6).

This permit shall become effective on March 27, 2024.

This permit and authorization to operate shall expire at midnight March 27, 2029.

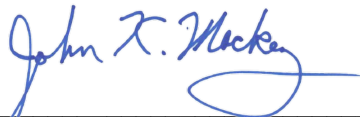

John K. Mackey, P.E.
Director
Utah Division of Water Quality

TABLE OF CONTENTS

PART I CONSTRUCTION PERMIT ISSUANCE..... 1
 A. Authorized Design and Construction 1

PART II SPECIFIC CONDITIONS 2
 A. Ground Water Classification..... 2
 B. Ground Water Quality 2
 C. Ground Water Protection Levels..... 2
 D. Permitted Facilities and Best Available Technology Standard 3
 E. Compliance Monitoring Requirements..... 3
 F. Non-Compliance Status 5
 G. Reporting Requirements 6
 H. Compliance Schedule 7

PART III MONITORING, RECORDING AND REPORTING REQUIREMENTS..... 9
 A. Representative Sampling 9
 B. Analytical Procedures..... 9
 C. Penalties for Tampering..... 9
 D. Reporting of Monitoring Results..... 9
 E. Compliance Schedules..... 9
 F. Additional Monitoring by the Permittee 9
 G. Records Contents 9
 H. Retention of Records 10
 I. Twenty-four Hour Notice of Noncompliance Reporting 10
 J. Other Noncompliance Reporting 10
 K. Inspection and Entry..... 10

PART IV COMPLIANCE RESPONSIBILITIES 11
 A. Duty to Comply..... 11
 B. Penalties for Violations of Permit Conditions 11
 C. Need to Halt or Reduce Activity not a Defense 11
 D. Duty to Mitigate 11
 E. Proper Operation and Maintenance 11

PART V GENERAL REQUIREMENTS 12
 A. Planned Changes 12
 B. Anticipated Noncompliance..... 12
 C. Permit Actions..... 12
 D. Duty to Reapply 12
 E. Duty to Provide Information..... 12
 F. Other Information..... 12
 G. Signatory Requirements..... 12
 H. Penalties for Falsification of Reports 13
 I. Availability of Reports 13
 J. Property Rights 13
 K. Severability 13
 L. Transfers 13
 M. State Laws..... 14
 N. Reopener Provision 14

Tables
 Table 1 Background Ground Water Quality
 Table 2 Interim Ground Water Protection Levels
 Table 3 Maximum Allowable Liner Leakage Rate

Appendices

- Appendix A** Construction Permit Plans and Specifications
- Appendix B** Groundwater Monitoring Plan, ACES, LLC
- Appendix C** Cooling and Blowdown Water Evaporation Pond Operating Manual

PART I CONSTRUCTION PERMIT ISSUANCE

A. AUTHORIZED DESIGN AND CONSTRUCTION

As part of this ground water discharge permit, a construction permit will be issued to ACES to construct the cooling water and blowdown water pond, and ancillary support facilities. The construction permit will be issued concurrently with this permit for the pond. Under authority of the Utah Water Quality Act, Section 19-5-108(1) Utah Code Ann. 1953, as amended and Utah Administrative Code R317-1, the authorized facilities will be constructed in accordance with the engineering design plans and specifications attached as Appendix A. Appendix A also includes the construction permits authorized by the Director. Part II.D of this permit describes the Best Available Technology (BAT) standards for these permitted facilities.

The authorized evaporation pond is constructed in accordance with the engineering design plans and specifications approved by the Construction Permit. The evaporation pond is constructed with a composite liner system with one leak detection recovery system. The pond footprint is approximately 34 acres with maximum allowable storage capacity of approximately 25 acres in area and 345 acre-feet of volume.

Design components include:

- 60-mil HDPE Primary Liner – a 60-mil high density polyethylene single-sided geomembrane primary liner will be installed to cover the pond basin and interior embankment slopes.
- Quadrants – The pond bottom will be graded into four quadrants with each containing a sump and collection system.
- Leak Detection and Infiltration Prevention (LCIP) Layer – underlying the primary liner the pond bottom in each quadrant will be graded to include approximately five 20-foot wide leak collection swales. Each swale will run from the high-point in the quadrant to a collection trench and pipe around the interior base of the berms. The swales and collection trenches and pipes will flow to a lined sump in each quadrant. The swales and collection trenches will be lined with 60-mil HDPE liner material. The swales and trenches will be filled with a select gravel and wrapped in geotextile to prevent stippling of the primary liner and to allow flow from the primary liner into the collection swales and trenches. These swales, collection trenches, and sumps will serve as a leak detection system and to reduce overall incidental leaking and infiltration from the primary liner due to accepted manufacturing pinholes and installation imperfections which are factored into the leak rate.
- Leak Detection Monitoring – The leak detection and infiltration reduction system will allow any liquids that collect in the sumps in each quadrant to be pumped back into the pond. Volumes of liquids collected in the sumps will be monitored and compared to the primary liner leak rate divided for each quadrant. This will provide early detection of leaks from the primary liner. Due to some liners performing better than manufacturer expectations for the leak rate, the sumps volumes will be recorded and pond specific leak rates for the sumps will be developed for more sensitive detection of increased flow to the sumps and better leak detection.
- Leak Detection Piezometers – Three piezometers will be installed in the down-gradient berms to monitor water levels within the embankment to assess potential leakage from the pond and the stability of the berm.

PART II SPECIFIC CONDITIONS

A. GROUND WATER CLASSIFICATION

Based on ground water quality data submitted in the permit application and offsite monitoring wells, ground water at the site is defined as Class II Drinking Water Quality Ground Water.

B. BACKGROUND GROUND WATER QUALITY

Table 1 provides background ground water quality data from wells completed in the aquifers and zones located east of the cooling and blowdown water pond in the vicinity of the ACES brine evaporation ponds.

Table 1: Background Ground Water Quality

Aquifer	Water Table (Nov 2017)	Water Table (Nov 2017)	Shallow Artesian (May 2013)	Deep Artesian (May 2013)
Well	B-P1-4	B-P1-9	Egg Farm	IPP
Parameter (mg/l)				
Alkalinity (as CaCO ₃)	229	299		
Chloride	103	157	64	37
Sulfate	39	60	66	27
Total dissolved solids	448	652	328	249
Calcium	20	163	17	15.2
Magnesium	22	58	7	9.2
Potassium	8	13	2	3.5
Sodium	114	149	75	48
pH (units)	8.1	7.7	7.9	7.07
Conductivity (umhos/cm)	808	1090	565	410

units = mg/L

C. GROUND WATER PROTECTION LEVELS

Ground water quality monitoring of the water table aquifer around the cooling and blowdown water pond will be conducted using the following monitoring wells following installation and development: EVM-201, EVM-202, EVM-203, EVM-204, and EVM-205. Following an accelerated sampling program and data evaluation, this list might be modified.

Table 2 provides interim ground water protection levels for the water table aquifer. These protection levels are based on Table 1 and shallow water table aquifer water samples collected from nearby brine evaporation pond monitoring wells. These interim protection levels will be adjusted if necessary following the accelerated sampling period for newly installed monitoring wells. See Part II.H.1 for details.

Table 2: Interim Ground Water Protection Levels

Parameter	Protection Level (mg/l)
pH (units)	6.5-8.5 ^(a)
Chloride	150
Sodium	200
Total Dissolved Solids	750

(a) Class II Ground Water Quality Standard

D. PERMITTED FACILITIES AND BEST AVAILABLE TECHNOLOGY (BAT) STANDARD

1. Authorized Construction - the project facilities authorized by this permit consist the cooling and blowdown water pond, and ancillary support facilities for the future planned hydrogen production facility,
2. BAT Performance Monitoring - Best available technology monitoring will include a minimum vertical freeboard, maximum allowable leakage rate, and maximum allowable head monitoring. These performance standards are based on *Equations for Calculating the Rate of Liquid Migration through Composite Liners due to Geomembrane Defects* (Giroud, 1997).
 - a. Minimum Vertical Freeboard – a minimum of 36 inches of vertical freeboard shall be maintained to ensure total containment of the evaporation/surge pond and peripheral ditches.
 - b. Maximum Allowable Leakage Rate Manufacturer – based on the maximum pond capacity of 34 acres (freeboard level three feet below the inside crest of the berm), the maximum allowable leakage rate through the primary HDPE liner of the evaporation/surge pond will be 8 gallons per minute.
 - c. Maximum Allowable Leakage Rate Performance – The maximum allowable performance leakage rate for the Cooling and Blowdown Water pond will be developed in the Cooling and Blowdown Pond Operating Manual. The pond will take many years to fill and the operator will develop expected leak rates for the pond as the hydraulic head increases during filling. This will ensure that leaks below the 8 gpm expected at full capacity, but above what would be expected for lower volume will be detected. The operating manual will be submitted for director approval prior to the pond becoming operational.
 - d. Maximum Allowable Head – the maximum head in each of the leak detection sumps will be managed by pumping leakage collected in the sumps back into the respective pond. Head will be kept below the top of the sump at all times, as described in Appendix C of the ACES Brine Evaporation Ponds Operating Manual. Fluids will be pumped from the sumps at a rate greater 8 gallons per minute divided by four for each sump or the performance pump rate established in the pond operation manual, to match the pond leak rate through the liner.
3. Spill Containment - The permittee shall design, maintain and construct all pipelines and pumping facilities in a way that shall:
 - a. Prevent any spills or leakage from any contact with the ground surface or ground water.

Any spill that does come into contact with the ground surface or ground water shall be reported in accordance with Part III.I.

E. COMPLIANCE MONITORING REQUIREMENTS

1. Compliance Monitoring Points

- a. Leak Detection - The Leak Collection and Infiltration Prevention (LCIP) layer installed under the evaporation pond liner will serve as a ground water compliance mechanism and monitoring point.
- b. Compliance Wells – Monitoring wells will serve as ground water compliance monitoring points for the water table aquifer. The monitoring wells will be installed before the pond is put into operation.
- c. Ground Water Monitoring Plan - All water quality monitoring shall be conducted in accordance with the ground water monitoring plan (Appendix B).
- d. Protection of Monitoring Wells - All compliance monitoring wells must be protected from damage due to surface vehicular traffic or contamination due to surface spills. All compliance monitoring wells shall be maintained in full operational condition for the life of this permit. Any compliance monitoring well that becomes damaged beyond repair or is rendered unusable for any reason will be replaced by the permittee within 90 days or as directed by the Director.
- e. Berm Wall Piezometers – If the piezometers installed in the berm walls of the cooling and blowdown water pond show elevated water levels indicating a release has occurred, it will be reported in accordance with Part III.I.

2. Ground Water Compliance Monitoring

- a. Water Level Measurements – water level measurements shall be made in each monitoring well prior to any well purging or collection of ground water samples. These measurements will be made from a surveyed permanent reference point clearly demarcated on the top of the well or surface casing. Water level measurements will be made to the nearest 0.01 foot.
- b. Ground Water Quality Samples - samples of ground water from compliance monitoring wells will be collected for laboratory analysis on a quarterly basis until the compliance schedule requirements of Part II.H.1 are met.
 - 1) Analysis by Certified Laboratories - analysis of all ground water samples shall be performed by a laboratory certified by the Utah Department of Health.
 - 2) Ground Water Analytical Methods - methods used to analyze ground water samples must comply with the following:
 - i) Methods cited in UAC R317-6-6.3L, and
 - ii) Method detection limits are less than Ground Water Protection Levels in Part II.C Table 2
 - 3) Analysis Parameters - the following analyses will be conducted on all ground water samples collected:

- i) Field Parameters - pH, temperature, and specific conductance.
 - ii) Laboratory Parameters – including:
Protection Level Parameters in Part II.C Table 2
- 3. Leak Detection Sump Monitoring
 - a. Flow Measurement – When the pond is initially filling, the pumping rate of fluids pumped from the leak collection and infiltration prevention (LCIP) sumps and returned to the pond will be monitored, recorded and compared to the Maximum Allowable Leakage Rates in Table 3 Part II.F.3. below. After the pond has been filled and leakage rates stabilize, the pumping rate of fluids pumped from the LCIP sumps and returned to the pond will be monitored weekly and compared to the Maximum Allowable Leakage Rates in Table 3 Part II.F.3. below.
 - b. Sump Fluids —fluids detected in a leak detection sump will be pumped to the evaporation pond surface to minimize maximum allowable head.

F. NON-COMPLIANCE STATUS

- 1. Probable Out-of-Compliance Status - The permittee shall evaluate results of each ground water sampling event to determine any exceedance of the Ground Water Protection Levels found in Part I.C above. Upon determination that a Ground Water Protection Level has been exceeded at any downgradient compliance monitoring well, the permittee shall:
 - a. Immediately re-sample the monitoring well(s) found to be in probable out-of-compliance status for laboratory analysis of the exceeded protection level parameter(s). Submit the analytical results thereof, and notify the Director of the probable out-of-compliance status within 30 days of the initial detection.
 - b. Upon exceedance of any one parameter listed in Table 2 for two consecutive sampling events, immediately implement an accelerated schedule of monthly sampling analysis, consistent with the requirements of this permit. This monthly sampling will continue until the compliance status can be determined by the Director. Reports of the results of this sampling will be submitted to the Director as soon as they are available, but not later than 30 days from each date of sampling.
- 2. Out-of-Compliance Status Based on Confirmed Exceedance of Permit Ground Water Protection Levels
 - a. Out of Compliance Status shall be defined as follows:

For parameters that have been defined as detectable in the ground water and for which protection levels have been established, out-of-compliance shall be defined as two consecutive samples exceeding the protection level.
 - b. Notification and Accelerated Monitoring - upon determination by the permittee or the Director, in accordance with UAC R317-6-6.17, that an out-of-compliance status exists, the permittee shall:
 - 1) Verbally notify the Director of the out-of-compliance status or acknowledge Director Notice that such a status exists within 24 hours of receipt of data, and

- 2) Provide written notice within 5 days of the determination, and
 - 3) Continue an accelerated schedule of monthly ground water monitoring for at least two months and continue monthly monitoring until the facility is brought into compliance, or as determined by the Director.
- c. Source and Contamination Assessment Study Plan - within 30 days after the written notice to the Director required in Part II.F.2.b.2, above, the permittee shall submit an assessment study plan and compliance schedule for:
- 1) Assessment of the source or cause of the contamination, and determination of steps necessary to correct the source.
 - 2) Assessment of the extent of the ground water contamination and any potential dispersion.
 - 3) Evaluation of potential remedial actions to restore and maintain ground water quality, and ensure that the ground water standards will not be exceeded at the compliance monitoring wells.
3. Out-of-Compliance Status Based Upon Failure to Maintain Best Available Technology - In the event that LCIP monitoring indicates a violation of any of the construction or performance standards outlined in Part II.D of this permit, including an exceedance of leakage rates from Table 3 below, the permittee shall submit to the Director a notification and description of the violation in accordance with Part III.I of this permit. If the Maximum Allowable Leakage Rates in Table 3 are exceeded, corrective actions will be initiated following the procedures described in the attached Groundwater Monitoring Plan (Section 3.4 of Appendix B) and Cooling and Blowdown Water Evaporation Ponds Operating Manual (Appendix C).

Table 3 Maximum Allowable Liner Leakage Rates

Monitoring System Component	Cooling and Blowdown Pond
LCIP sumps Manufacturer rate	8 gallons per minute/ 2 gallons per minute each sump
LCIP sumps Performance rate	To be determined in pond operation manual

G. REPORTING REQUIREMENTS

1. Quarterly Ground Water Monitoring - monitoring required in Part II.E.2 above shall be reported according to the schedule in Table 4 below, unless modified by the Director:

Table 4: Compliance Monitoring Report Schedule

Quarter	Report Due Date
1 st (January, February, March)	April 30th
2 nd (April, May, June)	July 31 st
3 rd (July, August, September)	October 31 st
4 th (October, November, December)	January 31 st

2. Water Level Measurements - water level measurements from ground water monitoring wells and pond piezometers will be reported as measured depth to ground water from the

surveyed casing measuring point, and ground water elevations as converted by casing measuring point elevations.

3. Ground Water Quality Sampling - reporting will include:
 - a. Field Data Sheets - or copies thereof, including the field measurements, required in Part I.E.2.b.3 above, and other pertinent field data, such as: well name/number, date and time, names of sampling crew, type of sampling pump or bail, volume of water purged before sampling.
 - b. Laboratory Analytical Results - including date sampled, date received; and the results of analysis for each parameter, including: value or concentration, units of measurement, reporting limit (minimum detection limit for the examination), analytical method, and the date of the analysis.
4. Monthly Leak Detection Monitoring - reporting will include:
 - a. The volume of fluid pumped from the leak detection sumps, tabulated either daily or monthly, depending on the monitoring interval.
 - b. The disposition of any fluids pumped from the leak detection sump.
5. Electronic Filing Requirements - In addition to submittal of the hard copy data, above, the permittee will electronically submit the required ground water monitoring data in the electronic format specified by the Director. The data may be submitted by e-mail, compact disc, or other approved transmittal mechanism.
6. Monitoring Well As-Built Report - For each well constructed the permittee shall submit diagrams and descriptions of the final completion of the monitoring wells. The report is due within 60 days of the date of well completion. The report shall include:
 - a. Casing: depth, diameter, and type of material.
 - b. Screen: length, depth interval, diameter, material type, slot size.
 - c. Sand Pack: depth interval, material type and grain size.
 - d. Annular Seals: depth interval, material type.
 - e. Surface Casing and Cap: depth, diameter, material type, protection measures constructed.
 - f. Elevation and Well Location: ground surface elevation, elevation of water level measuring point, latitude and longitude in hours, minutes and seconds.
 - g. Well construction description, well completion description, results of well pump tests or slug tests.

H. COMPLIANCE SCHEDULE

1. **Cooling and Blowdown Water Pond Operating Manual.** Prior to receiving DWQ approval to use the Cooling and Blowdown Water Pond a *Cooling and Blowdown Water Pond Operating Manual/Standard Operating Plan* shall be submitted for Director review and approval. The manual shall describe pond monitoring, operation, maintenance, and repair procedures in detail. The manual will also develop specific performance-based leak

rates for the leak collection and infiltration prevention sumps to be used as enforceable limits during the filling of the pond. The manual must be approved by the director prior to the operation of the pond. Once approved, the document will be enforceable as Appendix C to this permit.

2. **Accelerated Background Monitoring Report.** Independent samples will be collected quarterly from each well according to the requirements of Part II.E.2b above until a total of eight (8) sampling events have been completed. An *Accelerated Background Monitoring Report* shall be submitted with the quarterly report for the 8th sampling event. The report shall include the following statistical calculations presented in spreadsheet format for each parameter in Table 2 for each compliance monitoring well:

- 1) Non-detect values converted to the detection limit times 0.25
- 2) Mean concentration
- 3) Standard deviation
- 4) Mean concentration plus 2 standard deviations
- 5) Mean concentration of all parameters times 1.25
- 6) Ground water quality standard times 0.25

Following DWQ review and approval, the interim Ground Water Class Protection Levels of Table 2 will be adjusted if necessary to comply with UAC R317-6-4. The Director will then determine if it is appropriate to adjust compliance monitoring frequency from quarterly to semi-annual.

4. **Final Closure Plan.** In the event that the permittee decides to discontinue its operations at the facility the permittee shall notify the Director of such a decision and submit a Final Closure Plan within 180 days prior to the closure of the facility. The permittee shall resubmit Final Closure Plans within 60 days of receipt of written notice of deficiencies therein.

PART III MONITORING, RECORDING AND REPORTING REQUIREMENTS

- A. REPRESENTATIVE SAMPLING
Samples taken in compliance with the monitoring requirements established under Part II shall be representative of the monitored activity.
- B. ANALYTICAL PROCEDURES
Water sample analysis must be conducted according to test procedures specified under UAC R317-6-6.3.L, unless other test procedures have been specified in this permit.
- C. PENALTIES FOR TAMPERING
The Act provides that any person who falsifies, tampers with, or knowingly renders inaccurate, any monitoring device or method required to be maintained under this permit shall, upon conviction, be punished by a fine of not more than \$10,000 per violation, or by imprisonment for not more than six months per violation, or by both.
- D. REPORTING OF MONITORING RESULTS
Monitoring results obtained during each reporting period specified in the permit, shall be submitted to the Director, Utah Division of Water Quality at the following address no later than the 30th day of the month following the completed reporting period:
- State of Utah
Division of Water Quality
P.O. Box 144870
Salt Lake City, Utah 84114-4870
Attention: Ground Water Protection Section
Electronic reporting submission portal: <https://deq.utah.gov/water-quality/water-quality-electronic-submissions>
- E. COMPLIANCE SCHEDULES
Reports of compliance or noncompliance with, or any progress reports on interim and final requirements contained in any Compliance Schedule of this permit shall be submitted no later than 14 days following each schedule date.
- F. ADDITIONAL MONITORING BY THE PERMITTEE
If the permittee monitors any pollutant more frequently than required by this permit, using approved test procedures as specified in this permit, the results of this monitoring shall be included in the calculation and reporting of the data submitted. Such increased frequency shall also be indicated.
- G. RECORDS CONTENTS
Records of monitoring information shall include:
1. The date, exact place, and time of sampling or measurements;
 2. The individual(s) who performed the sampling or measurements;
 3. The date(s) and time(s) analyses were performed;
 4. The individual(s) who performed the analyses;
 5. The analytical techniques or methods used; and,
 6. The results of such analyses.

H. RETENTION OF RECORDS

The permittee shall retain records of all monitoring information, including all calibration and maintenance records and copies of all reports required by this permit, and records of all data used to complete the application for this permit, for a period of at least three years from the date of the sample, measurement, report or application. This period may be extended by request of the Director at any time.

I. TWENTY-FOUR HOUR NOTICE OF NONCOMPLIANCE REPORTING

1. The permittee shall verbally report any noncompliance which may endanger public health or the environment as soon as possible, but no later than 24 hours from the time the permittee first became aware of the circumstances. The report shall be made to the Utah Department of Environmental Quality 24-hour number, (801) 536-4123, or to the Division of Water Quality, Ground Water Protection Section at (801) 536-4300, during normal business hours (Monday through Friday 8:00 am - 5:00 pm Mountain Time).
2. A written submission shall also be provided to the Director within five days of the time that the permittee becomes aware of the circumstances. The written submission shall contain:
 - a. A description of the noncompliance and its cause;
 - b. The period of noncompliance, including exact dates and times;
 - c. The estimated time noncompliance is expected to continue if it has not been corrected; and,
 - d. Steps taken or planned to reduce, eliminate, and prevent reoccurrence of the noncompliance.
3. Reports shall be submitted to the addresses in Part III.D, Reporting of Monitoring Results.

J. OTHER NONCOMPLIANCE REPORTING

Instances of noncompliance not required to be reported within 24 hours, shall be reported at the time that monitoring reports for Part II.E are submitted.

K. INSPECTION AND ENTRY

The permittee shall allow the Director, or an authorized representative, upon the presentation of credentials and other documents as may be required by law, to:

1. Enter upon the permittee's premises where a regulated facility or activity is located or conducted, or where records must be kept under the conditions of the permit;
2. Have access to and copy, at reasonable times, any records that must be kept under the conditions of this permit;
3. Inspect at reasonable times any facilities, equipment (including monitoring and control equipment), practices, or operations regulated or required under this permit; and,
4. Sample or monitor at reasonable times, for the purpose of assuring permit compliance or as otherwise authorized by the Act, any substances or parameters at any location.

PART IV COMPLIANCE RESPONSIBILITIES

A. DUTY TO COMPLY

The permittee must comply with all conditions of this permit. Any permit noncompliance constitutes a violation of the Act and is grounds for enforcement action; for permit termination, revocation and reissuance, or modification; or for denial of a permit renewal application. The permittee shall give advance notice to the Director of any planned changes in the permitted facility or activity which may result in noncompliance with permit requirements.

B. PENALTIES FOR VIOLATIONS OF PERMIT CONDITIONS

The Act provides that any person who violates a permit condition implementing provisions of the Act is subject to a civil penalty not to exceed \$10,000 per day of such violation. Any person who willfully or negligently violates permit conditions is subject to a fine not exceeding \$25,000 per day of violation. Any person convicted under Section 19-5-115(2) of the Act a second time shall be punished by a fine not exceeding \$50,000 per day. Nothing in this permit shall be construed to relieve the permittee of the civil or criminal penalties for noncompliance.

C. NEED TO HALT OR REDUCE ACTIVITY NOT A DEFENSE

It shall not be a defense for a permittee in an enforcement action that it would have been necessary to halt or reduce the permitted activity in order to maintain compliance with the conditions of this permit.

D. DUTY TO MITIGATE

The permittee shall take all reasonable steps to minimize or prevent any discharge in violation of this permit which has a reasonable likelihood of adversely affecting human health or the environment.

E. PROPER OPERATION AND MAINTENANCE

The permittee shall at all times properly operate and maintain all facilities and systems of treatment and control (and related appurtenances) which are installed or used by the permittee to achieve compliance with the conditions of this permit. Proper operation and maintenance also includes adequate laboratory controls and quality assurance procedures. This provision requires the operation of back-up or auxiliary facilities or similar systems which are installed by a permittee only when the operation is necessary to achieve compliance with the conditions of the permit.

PART V GENERAL REQUIREMENTS

- A. PLANNED CHANGES
The permittee shall give notice to the Director as soon as possible of any planned physical alterations or additions to the permitted facility. Notice is required when the alteration or addition could significantly change the nature of the facility or increase the quantity of pollutants discharged.
- B. ANTICIPATED NONCOMPLIANCE
The permittee shall give advance notice of any planned changes in the permitted facility or activity which may result in noncompliance with permit requirements.
- C. PERMIT ACTIONS
This permit may be modified, revoked and reissued, or terminated for cause. The filing of a request by the permittee for a permit modification, revocation and reissuance, or termination, or a notification of planned changes or anticipated noncompliance, does not stay any permit condition.
- D. DUTY TO REAPPLY
If the permittee wishes to continue an activity regulated by this permit after the expiration date of this permit, the permittee must apply for and obtain a permit renewal or extension. The application should be submitted at least 180 days before the expiration date of this permit.
- E. DUTY TO PROVIDE INFORMATION
The permittee shall furnish to the Director, within a reasonable time, any information which the Director may request to determine whether cause exists for modifying, revoking and reissuing, or terminating this permit, or to determine compliance with this permit. The permittee shall also furnish to the Director, upon request, copies of records required to be kept by this permit.
- F. OTHER INFORMATION
When the permittee becomes aware that it failed to submit any relevant facts in a permit application, or submitted incorrect information in a permit application or any report to the Director, it shall promptly submit such facts or information.
- G. SIGNATORY REQUIREMENTS
All applications, reports or information submitted to the Director shall be signed and certified.
1. All permit applications shall be signed as follows:
 - a. For a corporation: by a responsible corporate officer;
 - b. For a partnership or sole proprietorship: by a general partner or the proprietor, respectively.
 - c. For a municipality, State, Federal, or other public agency: by either a principal executive officer or ranking elected official.
 2. All reports required by the permit and other information requested by the Director shall be signed by a person described above or by a duly authorized representative of that person. A person is a duly authorized representative only if:
 - a. The authorization is made in writing by a person described above and submitted to the Director, and,

- b. The authorization specified either an individual or a position having responsibility for the overall operation of the regulated facility or activity, such as the position of plant manager, operator of a well or a well field, superintendent, position of equivalent responsibility, or an individual or position having overall responsibility for environmental matters for the company. (A duly authorized representative may thus be either a named individual or any individual occupying a named position.)
- 3. Changes to Authorization. If an authorization under Part V.G.2 is no longer accurate because a different individual or position has responsibility for the overall operation of the facility, a new authorization satisfying the requirements of Part V.G.2 must be submitted to the Director prior to or together with any reports, information, or applications to be signed by an authorized representative.
- 4. Certification. Any person signing a document under this section shall make the following certification:

"I certify under penalty of law that this document and all attachments were prepared under my direction or supervision in accordance with a system designed to assure that qualified personnel properly gather and evaluate the information submitted. Based on my inquiry of the person or persons who manage the system, or those persons directly responsible for gathering the information, the information submitted is, to the best of my knowledge and belief, true, accurate, and complete. I am aware that there are significant penalties for submitting false information, including the possibility of fine and imprisonment for knowing violations."

H. PENALTIES FOR FALSIFICATION OF REPORTS

The Act provides that any person who knowingly makes any false statement, representation, or certification in any record or other document submitted or required to be maintained under this permit, including monitoring reports or reports of compliance or noncompliance shall, upon conviction be punished by a fine of not more than \$10,000 per violation, or by imprisonment for not more than six months per violation, or by both.

I. AVAILABILITY OF REPORTS

Except for data determined to be confidential by the permittee, all reports prepared in accordance with the terms of this permit shall be available for public inspection at the offices of the Director. As required by the Act, permit applications, permits, effluent data, and ground water quality data shall not be considered confidential.

J. PROPERTY RIGHTS

The issuance of this permit does not convey any property rights of any sort, or any exclusive privileges, nor does it authorize any injury to private property or any invasion of personal rights, nor any infringement of federal, state or local laws or regulations.

K. SEVERABILITY

The provisions of this permit are severable, and if any provision of this permit, or the application of any provision of this permit to any circumstance, is held invalid, the application of such provision to other circumstances, and the remainder of this permit, shall not be affected thereby.

L. TRANSFERS

This permit may be automatically transferred to a new permittee if:

1. The current permittee notifies the Director at least 30 days in advance of the proposed transfer date;
2. The notice includes a written agreement between the existing and new permittee containing a specific date for transfer of permit responsibility, coverage, and liability between them; and,
3. The Director does not notify the existing permittee and the proposed new permittee of his or her intent to modify, or revoke and reissue the permit. If this notice is not received, the transfer is effective on the date specified in the agreement mentioned in paragraph 2 above.

M. STATE LAWS

Nothing in this permit shall be construed to preclude the institution of any legal action or relieve the permittee from any responsibilities, liabilities, penalties established pursuant to any applicable state law or regulation under authority preserved by Section 19-5-117 of the Act.

N. REOPENER PROVISION

This permit may be reopened and modified (following proper administrative procedures) to include the appropriate limitations and compliance schedule, if necessary, if one or more of the following events occurs:

1. If new ground water standards are adopted by the Board, the permit may be reopened and modified to extend the terms of the permit or to include pollutants covered by new standards. The permittee may apply for a variance under the conditions outlined in R317-6-6.4.D.
2. If alternative compliance mechanisms are required.
3. If subsequent ground water monitoring data reveals the background water quality values in Part I Table 1 are not accurate.

APPENDIX A

CONSTRUCTION PERMIT
PLANS AND SPECIFICATIONS



State of Utah

SPENCER J. COX
Governor

DEIDRE HENDERSON
Lieutenant Governor

Department of
Environmental Quality

Kimberly D. Shelley
Executive Director

DIVISION OF WATER QUALITY
John K. Mackey, P.E.
Director

January 23, 2024

Via Email
Read Receipt Requested

William Myers
COO of Aces Delta, LLC
Advanced Clean Energy Storage 1, LLC
3165 East Millrock Drive, Suite 330
Holladay, Utah 84121

Subject: **Construction Permit for the Evaporation Pond**
Advanced Clean Energy Storage 1, LLC (ACES 1)

Dear Mr. Myers:

On November 6, 2023, the Division of Water Quality (DWQ) received the Advanced Clean Energy Storage 1, LLC (ACES 1) – Evaporation Pond Design Report – Revision 1. This Report was prepared by Overland Contracting and signed by David Dean Oxenford P.E. a Utah Professional Engineer (P.E.). The Evaporation Pond will contain process wastewater and cooling water blowdown flow from the ACES 1 hydrogen production facility.

The following is a summary of the proposed major construction projects:

- The Evaporation Pond is a partially incised pond with 3H:1V interior and exterior slopes with embankments up to 23 feet above the existing grade. The Evaporation Pond is lined with a single High-Density Polyethylene (HDPE) Liner with an underdrain system beneath the liner to detect leakage.

The plans and specifications, as submitted, comply with *the Utah Water Quality Rules, (R317, Utah Administrative Code)*. A **Construction Permit** is hereby issued as constituted by this letter, subject to the following conditions:

1. *Any revisions or modifications to the approved plans and specifications must be submitted to DWQ for review and approval, before construction or implementation thereof. Please submit any changes for review and approval directly to Woodrow Campbell, P.E., of the DWQ Ground Water Protection Section.*
2. *A written operations and maintenance manual, containing a description of the functioning of the facilities, an outline of routine maintenance procedures, and all checklists and maintenance logs needed for proper operation of the system, must be submitted and approved before the final inspection and operation of the system.*

3. *The approved facilities must not be placed in service unless DWQ has conducted a final inspection, reviewed and approved the As-Built Construction Certification Report, and provided written authorization to place the constructed facilities in service.*
4. *Construction activities that disturb one acre or more are required to obtain coverage under the Utah Pollutant Discharge Elimination System (UPDES) Storm Water General Permit for Construction Activities. The permit requires the development of a storm water pollution prevention plan (SWPPP) to be implemented and updated from the commencement of any soil disturbing activities at the site until final stabilization of the project. For more information, or to obtain permit coverage on-line, please go to: <https://deq.utah.gov/water-quality/general-construction-storm-water-updes-permits> .*

The plans and specifications for this project have been stamped and signed by a Professional Engineer currently licensed to practice in the state of Utah. The construction design, inspection supervision, and written construction certification of all work associated with this Construction Permit must be performed by a Professional Engineer licensed to practice in the state of Utah.

This Construction Permit will expire one year from the date of its issuance, as evidenced by the date of this letter, unless substantial progress is made in constructing the approved facilities or the plans and specifications have been resubmitted and the construction permit is reissued. This permit does not relieve you, in any way, of your obligations to comply with other applicable local requirements. You may contact Eric Larsen, Central Utah Public Health Department at 435-896-5451 ext. 315 or John Chartier DEQ District Engineer at 435-559-1969 for further assistance regarding local matters.

Please contact Mr. Campbell at the beginning of construction to allow periodic inspections to be scheduled. Upon completion of the project, a final inspection and approval of the As-Built Construction Certification Report is required before the approval to operate the completed facilities can be issued. Please remain in contact with Mr. Campbell to schedule the final inspection. The Construction Certification Report with final as-built drawings must include test results for the following construction quality assurance and quality control (CQA/QC) elements:

Soil Subgrade

- Proctor Curves,
- Soil Classification,
- Field Compaction Testing, and
- Subgrade Acceptance Certification.

Flexible Membrane Liner

- Panel Placement Log,
- Trial Seam Test Log,
- Seaming Record,
- Seam Test Record,
- Repair Log,
- As-Built Drawing,
- Manufactures Certification including QA/QC Testing of the Rolls, and
- Professional Engineer Certification.

If you have any questions about the above correspondence, please contact Mr. Woodrow Campbell at wwcampbell@utah.gov or (801) 536-4353.

Sincerely,

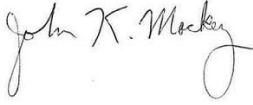

John K. Mackey, P.E.
Director

JKM/WWC/DJH/cjh/acr

Enclosures: 1. ACES Evap Pond Construction QA QC
 2. ACES Evap Pond Drawings Appendix A
 3. ACES Evap Pond CQA Plan Appendix K

Cc: Via Email w/out Enclosures
 Eric Larsen, Central Utah Public Health Department
 John Chartier, DEQ District Engineer
 Everett Taylor, Division of Dam Safety (everetttaylor@utah.gov)
 David D. Oxenford, (OxenfordDD@bv.com)

DWQ-2023-126581

Appendix A. Pond Drawings

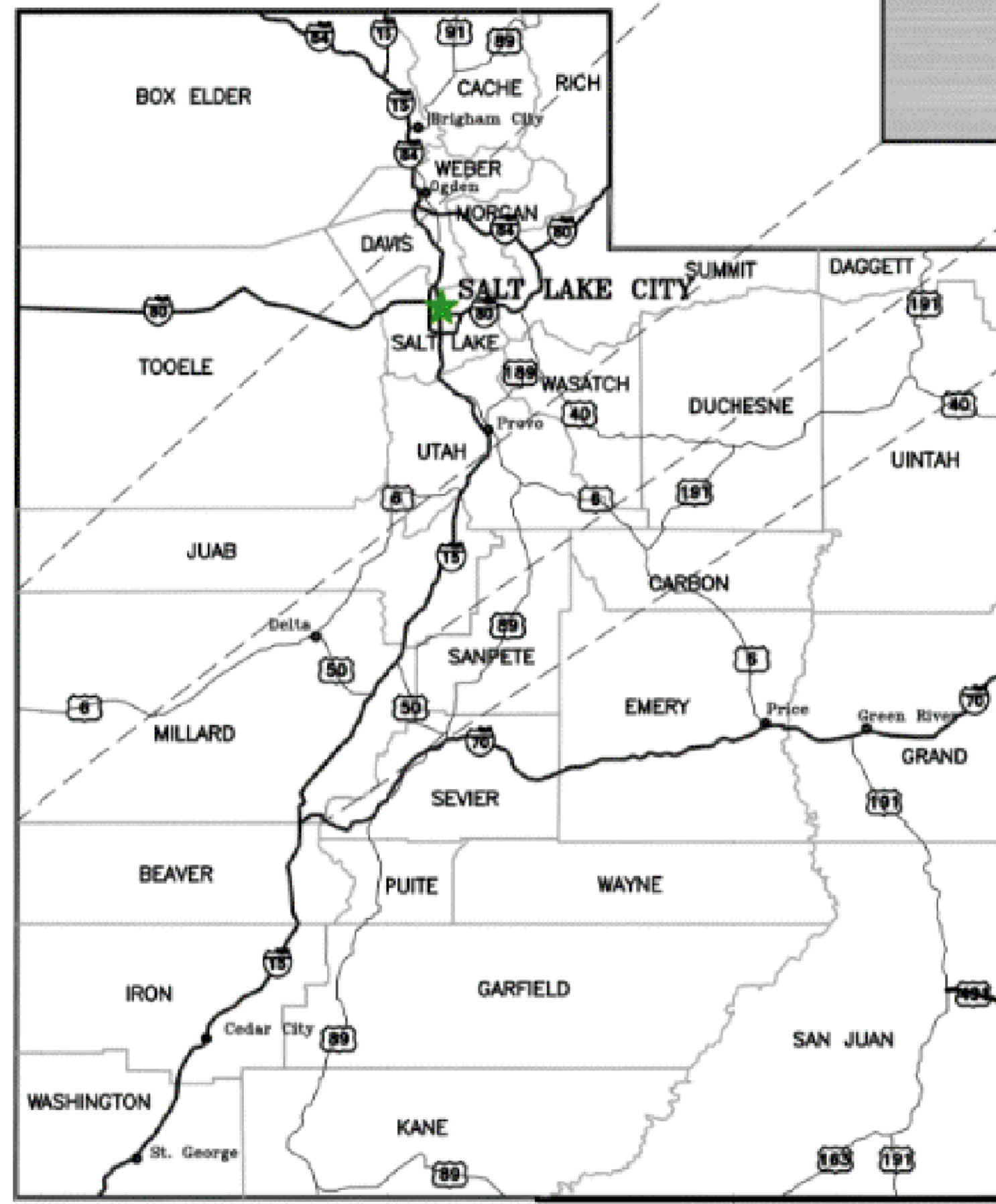

UTAH COUNTY MAP

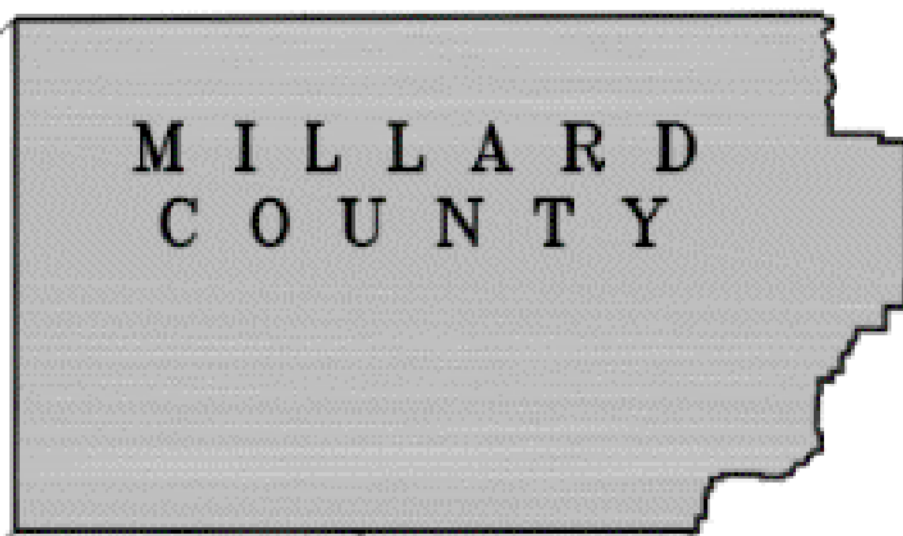

ADVANCED CLEAN ENERGY STORAGE I, LLC EVAPORATION POND APPROVED FOR CONSTRUCTION

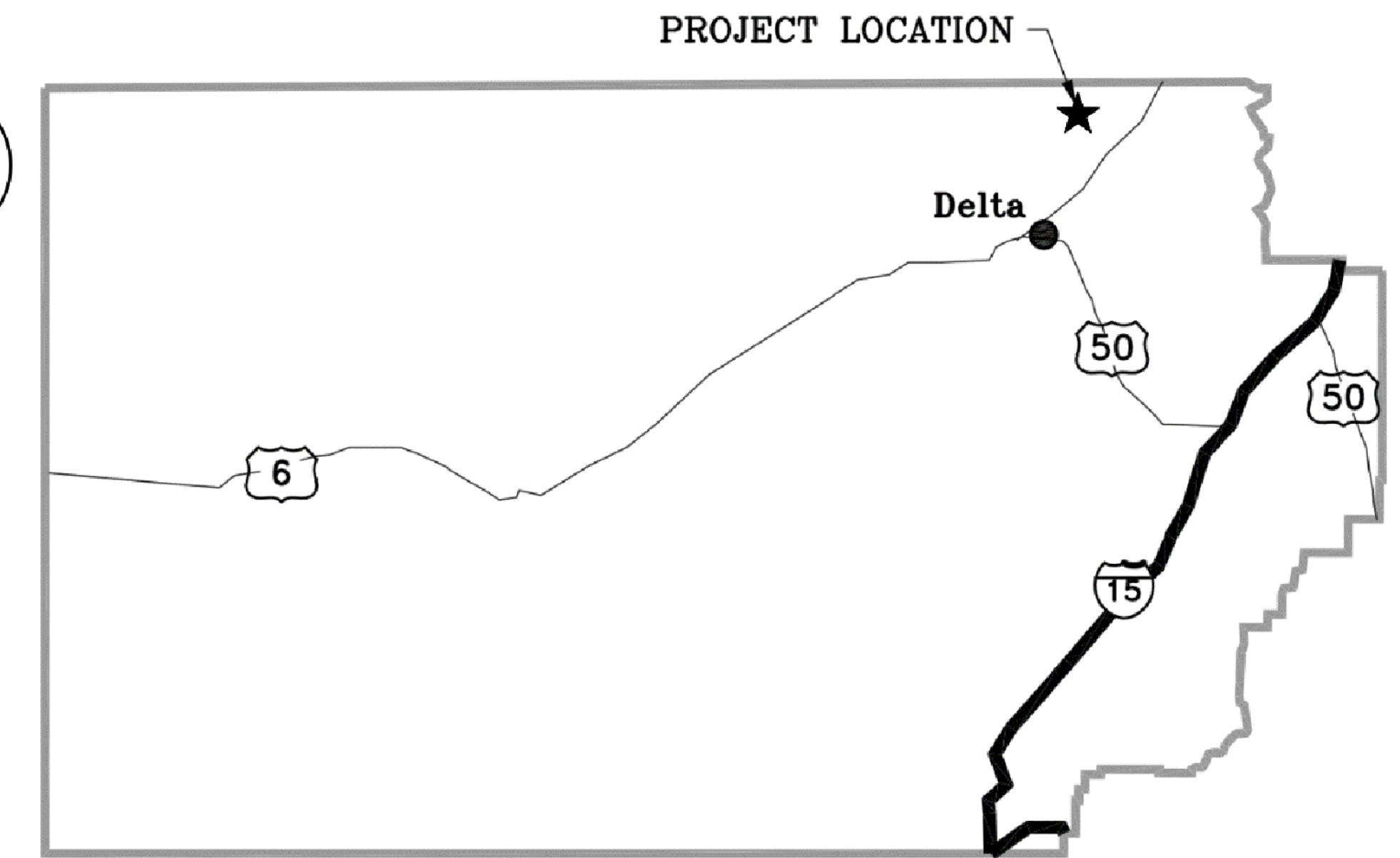
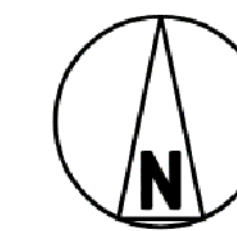

MILLARD COUNTY VICINITY MAP

DRAWING INDEX		
DWG NO.	TITLE	REV
411943-10STF-S3000	GRADING AND DRAINAGE - SITE - KEY PLAN, GENERAL NOTES, & LEGEND	1
411943-10STF-S3010	GRADING & DRAINAGE- SITE - PLAN - AREA 10	2
411943-10STF-S3011A	EVAPORATION POND - PLAN - TRENCHES & SUMPS	0
411943-10STF-S3011B	EVAPORATION POND - INSTRUMENTATION - PLAN	1
411943-10STF-S3050	EVAPORATION POND - SITE - SECTIONS PLAN VIEW	0
411943-10STF-S3051	EVAPORATION POND - SITE - SECTIONS PROFILE VIEW	0
288048-1STE-S3100	EROSION CONTROL - SITE - KEY PLAN, GENERAL NOTES AND LEGEND	2
288048-1STE-S3107	EROSION CONTROL - SITE - PLAN - AREA 7	2
288048-1STE-S3119	EROSION CONTROL - SITE - PLAN - AREA 19	1
411943-10STD-S3200	FENCING & SURFACING - SITE - KEY PLAN, GENERAL NOTES, & LEGEND	1
411943-10STD-S3210	FENCING & SURFACING - SITE - PLAN - AREA 10	2
411943-10STA-S3400	ROADS & PARKING - SITE - KEY PLAN, GENERAL NOTES & LEGEND	1
411943-10STA-S3405	ROADS & PARKING - SITE - PLAN - AREA 5	1
411943-10STF-S3911A	SITE - CIVIL - TYPICAL DETAILS - EVAPORATION POND	2
411943-10STF-S3911B	SITE - CIVIL - TYPICAL DETAILS - EVAPORATION POND	0

OWNERS ACCEPTANCE OF DRAWINGS

William Myers

11/6/23

NAME

SIGNATURE

DATE

NOTES:

- APPROVED GROUNDWATER RIGHTS # 68-2161, 68-2173 AND 68-2432 OWNED BY THE INTERMOUNTAIN POWER AGENCY WILL BE USED FOR THE WATER SUPPLY FOR THIS FACILITY.

APPROVED FOR CONSTRUCTION

THE DISTRIBUTION AND USE OF THE NATIVE FORMAT CAD FILE OF THIS DRAWING IS UNCONTROLLED. THE USER SHALL VERIFY TRACEABILITY OF THIS DRAWING TO THE LATEST CONTROLLED VERSION.

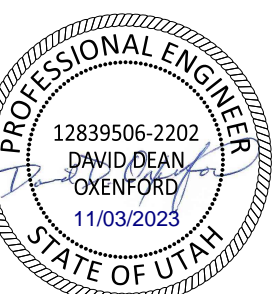

11/02/2023 09:34 PM

I HEREBY CERTIFY THAT THIS DOCUMENT WAS PREPARED BY ME OR UNDER MY DIRECT SUPERVISION AND THAT I AM A DULY REGISTERED PROFESSIONAL ENGINEER UNDER THE LAWS OF THE STATE OF UTAH. SIGNED: DAVID DEAN ORENFORD DATE: 03/NOV/23 REG NO: 12839506-2202		BLACK & VEATCH DESIGNER: MTS DRAWN: MTS CHECKED: CAF DATE: 03/NOV/23	PROJECT: ADVANCED CLEAN ENERGY STORAGE I, LLC ACES PROJECT I EVAPORATION POND COVER SHEET	DRAWING NUMBER: 411943-DS-0001 REV: 0
--	--	---	---	--

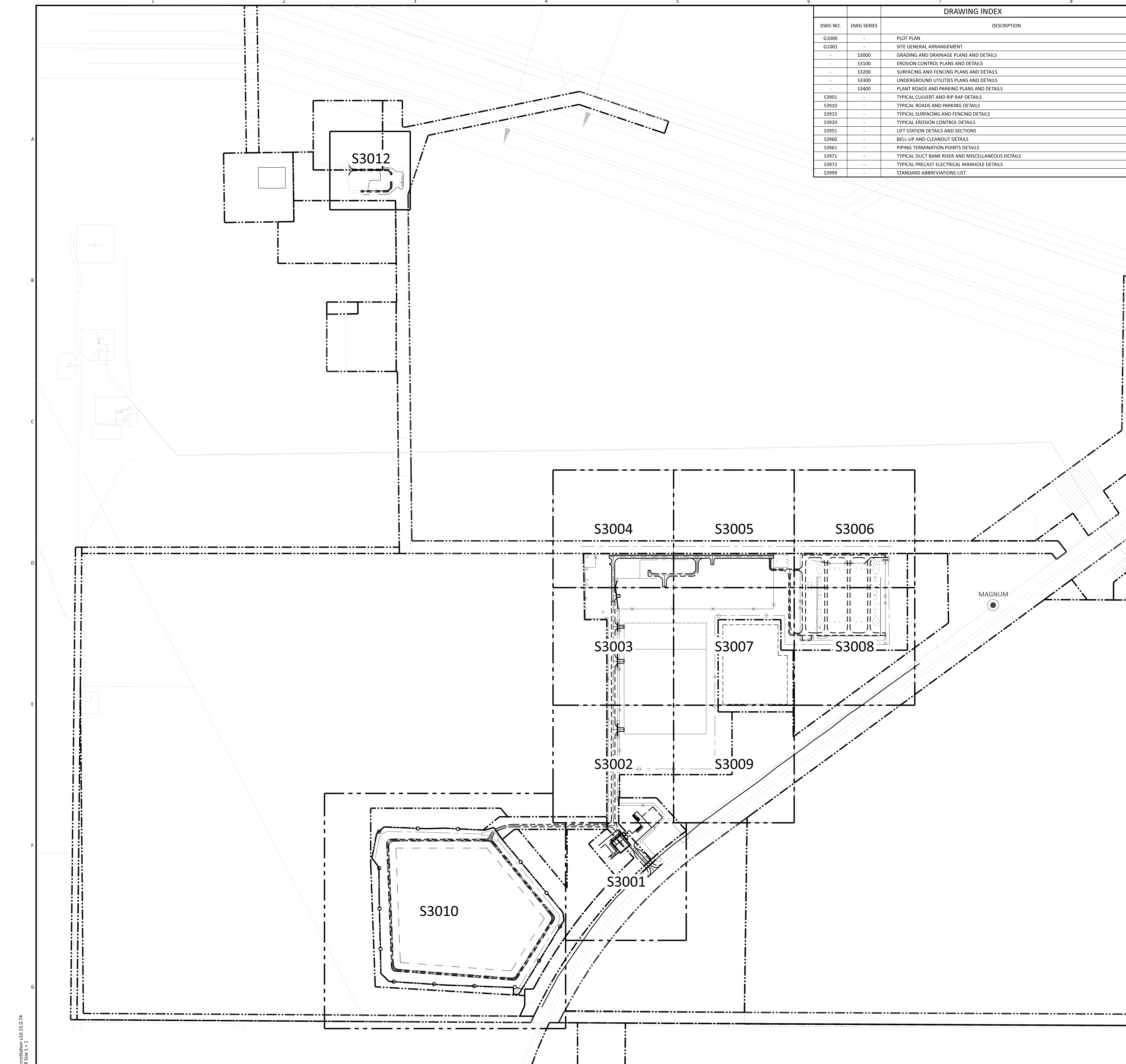

DRAWING INDEX		
DWG NO.	DWG SERIES	DESCRIPTION
G1000	-	PLOT PLAN
G1001	-	SITE GENERAL ARRANGEMENT
-	S3000	GRADING AND DRAINAGE PLANS AND DETAILS
-	S3100	EROSION CONTROL PLANS AND DETAILS
-	S3200	SURFACING AND FENCING PLANS AND DETAILS
-	S3300	UNDERGROUND UTILITIES PLANS AND DETAILS
-	S3400	PLANT ROADS AND PARKING PLANS AND DETAILS
S3901	-	TYPICAL CULVERT AND RIP RAP DETAILS
S3910	-	TYPICAL ROADS AND PARKING DETAILS
S3915	-	TYPICAL SURFACING AND FENCING DETAILS
S3920	-	TYPICAL EROSION CONTROL DETAILS
S3951	-	LIFT STATION DETAILS AND SECTIONS
S3960	-	BELL-UP AND CLEANOUT DETAILS
S3961	-	PIPING TERMINATION POINTS DETAILS
S3971	-	TYPICAL DUCT BANK RISER AND MISCELLANEOUS DETAILS
S3972	-	TYPICAL PRECAST ELECTRICAL MANHOLE DETAILS
S3999	-	STANDARD ABBREVIATIONS LIST

- GENERAL NOTES**
APPLICABLE TO ALL S3000 SERIES DRAWINGS
- HORIZONTAL CONTROL IS BASED ON THE DUCHESSNE LOCAL GROUND COORDINATE SYSTEM, IN UNITS OF US SURVEY FEET. SEE DRAWING 1GAU-G1000 FOR LOCATIONS OF EXISTING AND NEW PROJECT SURVEY CONTROL MONUMENTS.
 - VERTICAL CONTROL IS BASED ON NAVD88.
 - SEE DRAWING S3999 FOR THE STANDARD ABBREVIATION LIST.
 - FINISHED GRADE SHALL SLOPE UNIFORMLY BETWEEN GRADE BREAK LINES, FINISH SPOT ELEVATIONS, AND CONTOURS SHOWN ON THE PLANS AND AS INDICATED BY DIRECTION OF FLOW ARROWS.
 - A SMOOTH VERTICAL TRANSITION SHALL BE PROVIDED AT ROAD INTERSECTIONS.
 - SLOPES SHALL BE 3(H):1(V) OR FLATTER, UNLESS NOTED OTHERWISE.
 - SPOT ELEVATIONS AND CONTOURS ON THE S3000 SERIES DRAWINGS ARE THE TOP OF FINISHED GRADE ELEVATION. SUBTRACT THE FINISH SURFACING MATERIAL THICKNESS TO OBTAIN THE TOP OF SUBGRADE ELEVATION.
 - FINISHED GRADE SHALL BE SET 6 INCHES BELOW TOP OF CONCRETE UNLESS NOTED OTHERWISE. FINISHED GRADE SHALL SLOPE AWAY FROM THE STRUCTURE AT A MINIMUM SLOPE OF 3% FOR 10 FEET OR 2% FOR 5 FEET.
 - FINISHED CONTOURS SHALL TIE INTO EXISTING CONTOURS IN AREAS WHERE THERE IS INSUFFICIENT SURVEY DATA OF THE EXISTING GRADE.
 - OVER THE EXTENT OF AREAS TO BE CUT OR FILLED, THE EXISTING SURFACE DUST/TOPSOIL MATERIAL SHALL BE STRIPPED TO THE DEPTH REQUIRED TO OBTAIN STABLE SOIL AND A FIRM SURGRADE. UNSUABLE STRIPPED MATERIAL SHALL BE DISPOSSED ON SITE. THE DISPOSAL LOCATION AND PLACEMENT SHALL NOT BLOCK EXISTING STORMWATER DRAINAGE PATTERNS.

LEGEND
APPLICABLE TO ALL S3000 SERIES DRAWINGS

	PROPERTY LINE		SECTION OR DETAIL NUMBER
	LIMIT OF RIGHT OF WAY		DRAWING DESIGNATION NUMBER
	NEW SECURITY FENCE		
	SWITCHYARD FENCE		
	EXISTING FENCE		
	NEW CONTOUR		
	EXISTING CONTOUR		
	EXISTING RAILROAD		
	VEGETATION		
	NEW CULVERT		
	DITCH/SWALE FLOW INDICATOR		
	GRADE SURFACE FLOW INDICATOR		
	NEW SPOT ELEVATION		
	GRADE BREAK INDICATOR		
	SURVEY CONTROL MONUMENT		

EXTENSIVE REVISIONS
PER ECN N-S-0044

APPROVED FOR CONSTRUCTION

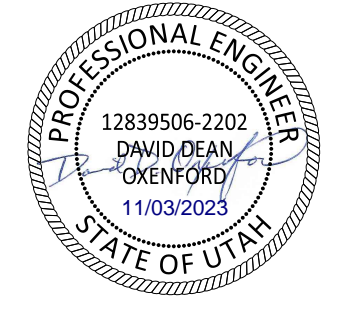

BLACK & VEATCH DESIGNER: CAP DRAWN: MTS CHECKED: AMM DATE: 21/SEP/22		ADVANCED CLEAN ENERGY STORAGE I, LLC ACES PROJECT I GRADING AND DRAINAGE - SITE KEY PLAN, GENERAL NOTES, & LEGEND	PROJECT: 411943-10STF-S3000 DRAWING NUMBER: 1 REV: 1
---	--	---	--

11/02/2023 04:45 PM
 11/02/2023 04:45 PM
 11/02/2023 04:45 PM

NO.	DATE	REVISIONS AND RECORD OF ISSUE	DRN	DES	CHK	PDE	APP
1	03/NOV/23	ISSUED PER ECN N-S-0044					
0	19/SEP/22	ISSUED FOR CONSTRUCTION					

I HEREBY CERTIFY THAT THIS DOCUMENT WAS PREPARED BY ME OR UNDER MY DIRECT SUPERVISION AND THAT I AM A DULY REGISTERED PROFESSIONAL ENGINEER UNDER THE LAWS OF THE STATE OF UTAH.

SIGNED: DAVID DEAN OXENFORD
 DATE: 17/AUG/22 REG. NO.: 12839506-2202

1. SEE DRAWING S3000 FOR GENERAL NOTES AND LEGEND.

EARTHWORKS SUMMARY (ESTIMATE)	
DESCRIPTION	EVAPORATION POND
CUT (CY)	196,000
FILL (CY)	134,000

NOTE: INDICATED FILL QUANTITY IS NON-COMPACTED. A COMPACTION FACTOR OF 13% IS EXPECTED.

EXTENSIVE REVISIONS PER ECN N-S-0044

KEY PLAN

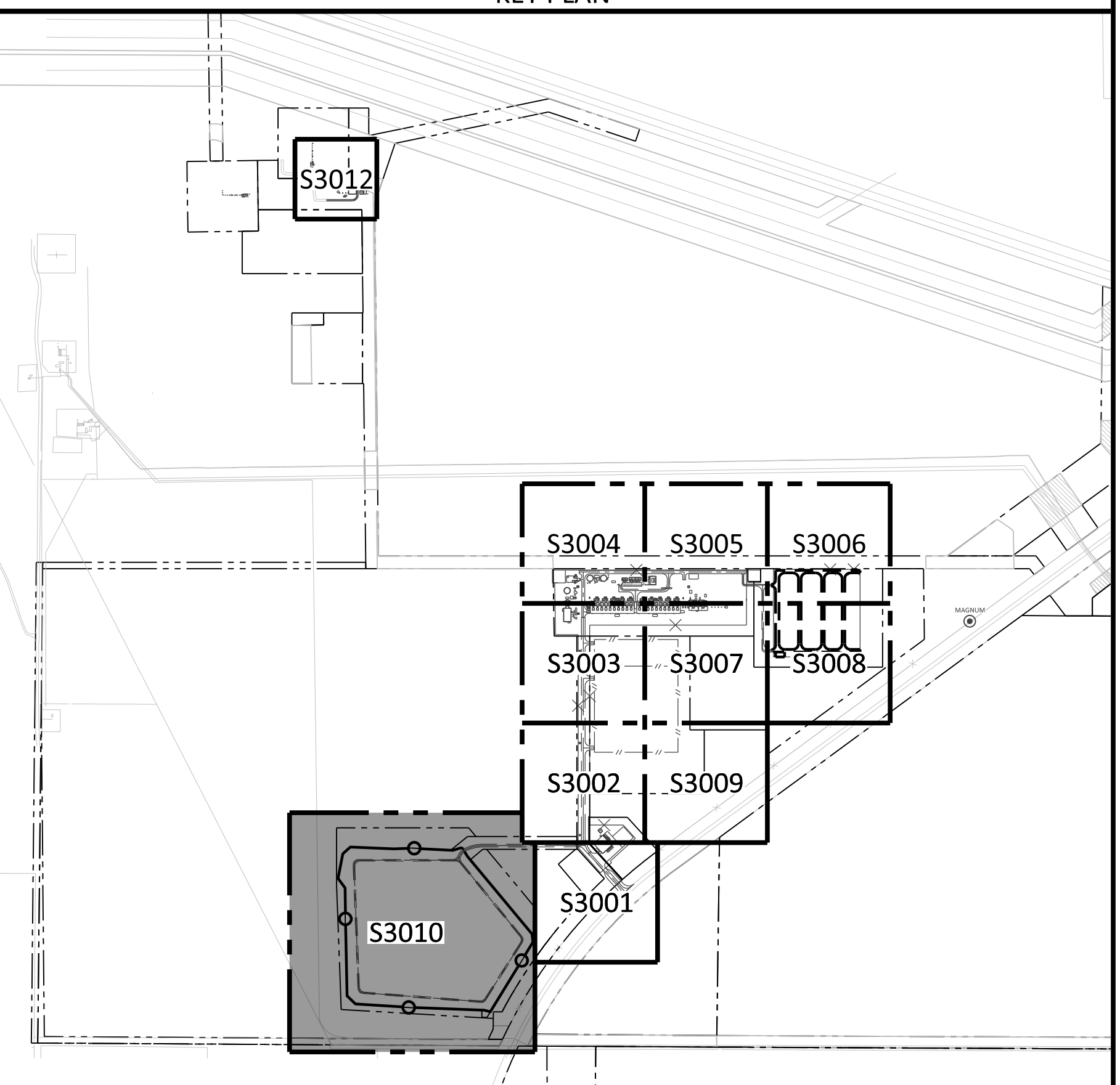

APPROVED FOR CONSTRUCTION

THE DISTRIBUTION AND USE OF THE NATIVE FORMAT CAD FILE OF THIS DRAWING IS UNCONTROLLED. THE USER SHALL VERIFY TRACEABILITY OF THIS DRAWING TO THE LATEST CONTROLLED VERSION.

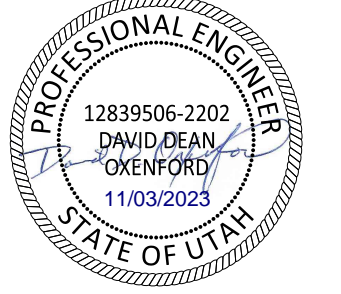

BLACK & VEATCH		PROJECT: ADVANCED CLEAN ENERGY STORAGE I, LLC	DRAWING NUMBER: 411943-10STF-S3010	REV: 2
DESIGNER: CAJ	DRAWN: MTS	CODE: ACES PROJECT I	DATE: 07/05/23	
CHECKED: AMM	DATE: 07/05/23	AREA: GRADING & DRAINAGE- SITE PLAN - AREA 10		

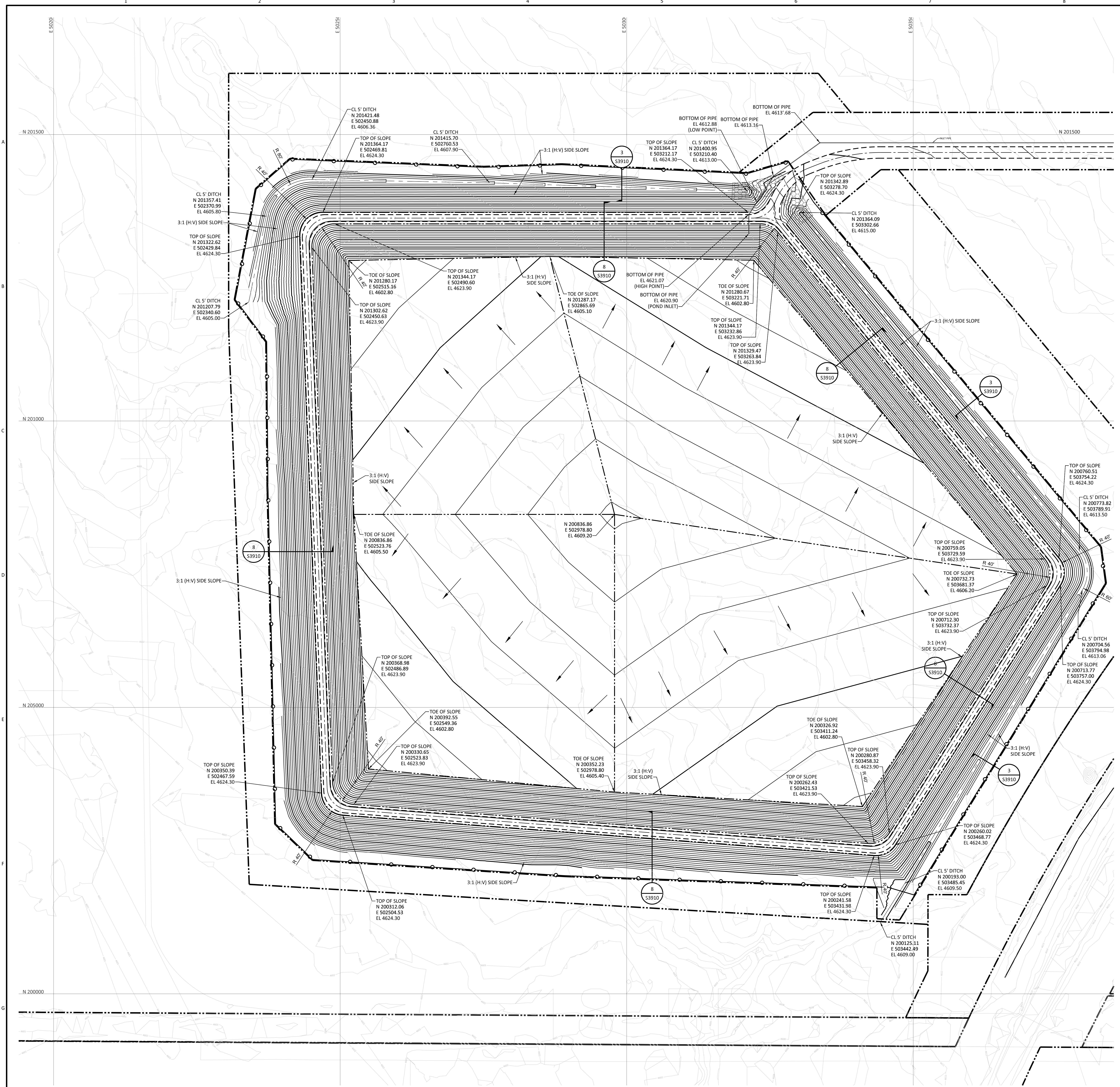

NO.	DATE	REVISIONS AND RECORD OF ISSUE
2	03/NOV/23	REVISED PER ECN N-S-0044
1	18/AUG/23	REVISED PER ECN N-S-0038
0	07/JUL/23	ISSUED FOR CONSTRUCTION

CAJ/CAJ/PPA/CJG
 MTS MTS CAF DDO CG
 MTS GDV CAF DDO CG
 MTS CAF AMM DDO CG
 DRN DES CHX PDE APP

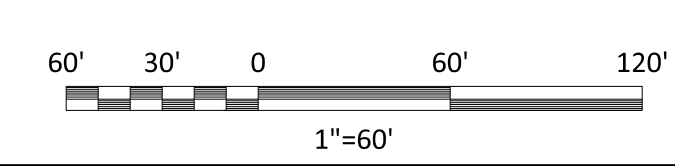
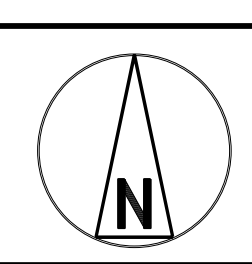

I HEREBY CERTIFY THAT THIS DOCUMENT WAS PREPARED BY ME OR UNDER MY DIRECT SUPERVISION AND THAT I AM A DULY REGISTERED PROFESSIONAL ENGINEER UNDER THE LAWS OF THE STATE OF UTAH.
 SIGNED: **DAVID DEAN OENENFORD**
 DATE: **07/JUL/23** REG. NO.: **12839506-2202**

M:\S3000\10STF\10STF-10.dwg
 11/02/2023 10:49 AM
 11/02/2023 10:49 AM

- 1. SEE DRAWING S3000 FOR GENERAL NOTES AND LEGEND.
- 2. SEE DRAWING S3911A FOR TRENCH AND SUMP DETAILS.

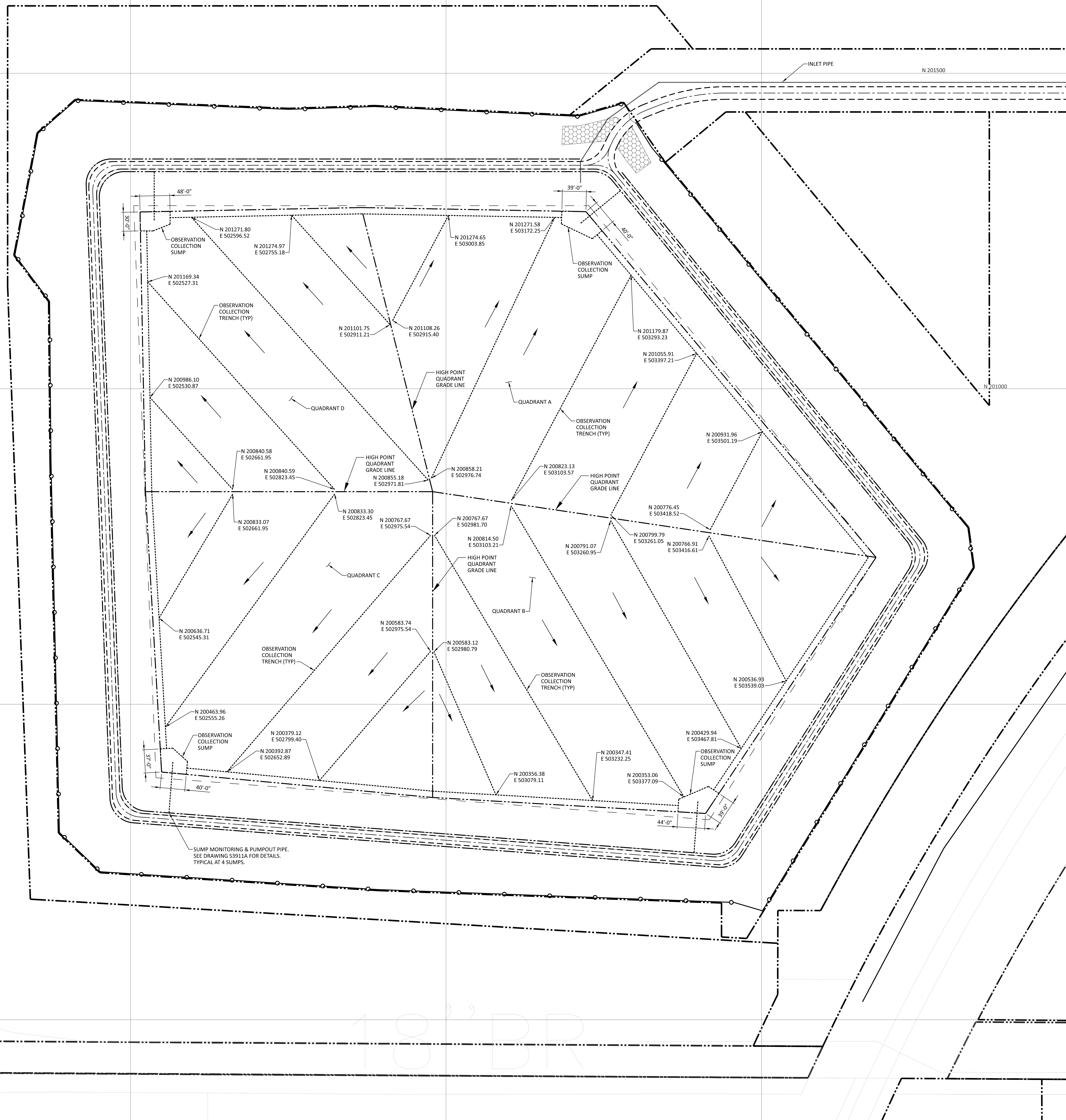

18' BR

18' BR

11/08/2023 11:17 AM
 11/08/2023 11:17 AM
 11/08/2023 11:17 AM

NO	DATE	REVISIONS AND RECORD OF ISSUE
0	03/NOV/23	ISSUED FOR CONSTRUCTION

CAF/APP/000 C/JG
 MTS MTS CAF DDD CIG
 DRN DES CHK PDE APP

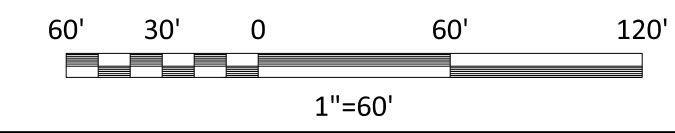
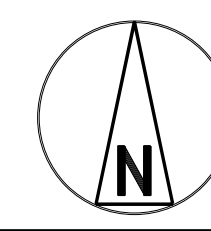

I HEREBY CERTIFY THAT THIS DOCUMENT WAS PREPARED BY ME OR UNDER MY DIRECT SUPERVISION AND THAT I AM A DULY REGISTERED PROFESSIONAL ENGINEER UNDER THE LAWS OF THE STATE OF UTAH. *David Dean Orenford* 11/08/2023
 SIGNED: DAVID DEAN ORENFORD
 DATE: 03/NOV/23 REG NO: 12839506-2202

BLACK & VEATCH
 DESIGNER: MTS DRAWN: MTS
 CHECKED: CAF DATE: 03/NOV/23

APPROVED FOR CONSTRUCTION
 THE DISTRIBUTION AND USE OF THE NATIVE FORMAT CAD FILE OF THIS DRAWING IS UNCONTROLLED. THE USER SHALL VERIFY TRACEABILITY OF THIS DRAWING TO THE LATEST CONTROLLED VERSION.

ADVANCED CLEAN ENERGY STORAGE I, LLC
 ACES PROJECT I
 EVAPORATION POND
 PLAN - TRENCHES & SUMPS

PROJECT: ADVANCED CLEAN ENERGY STORAGE I, LLC
 DRAWING NUMBER: 411943-10STF-S3011A
 REV: 0

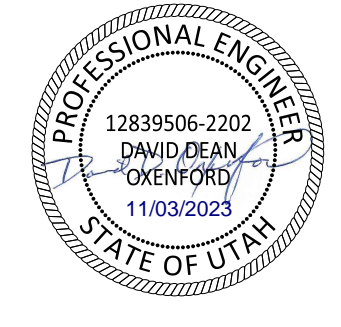

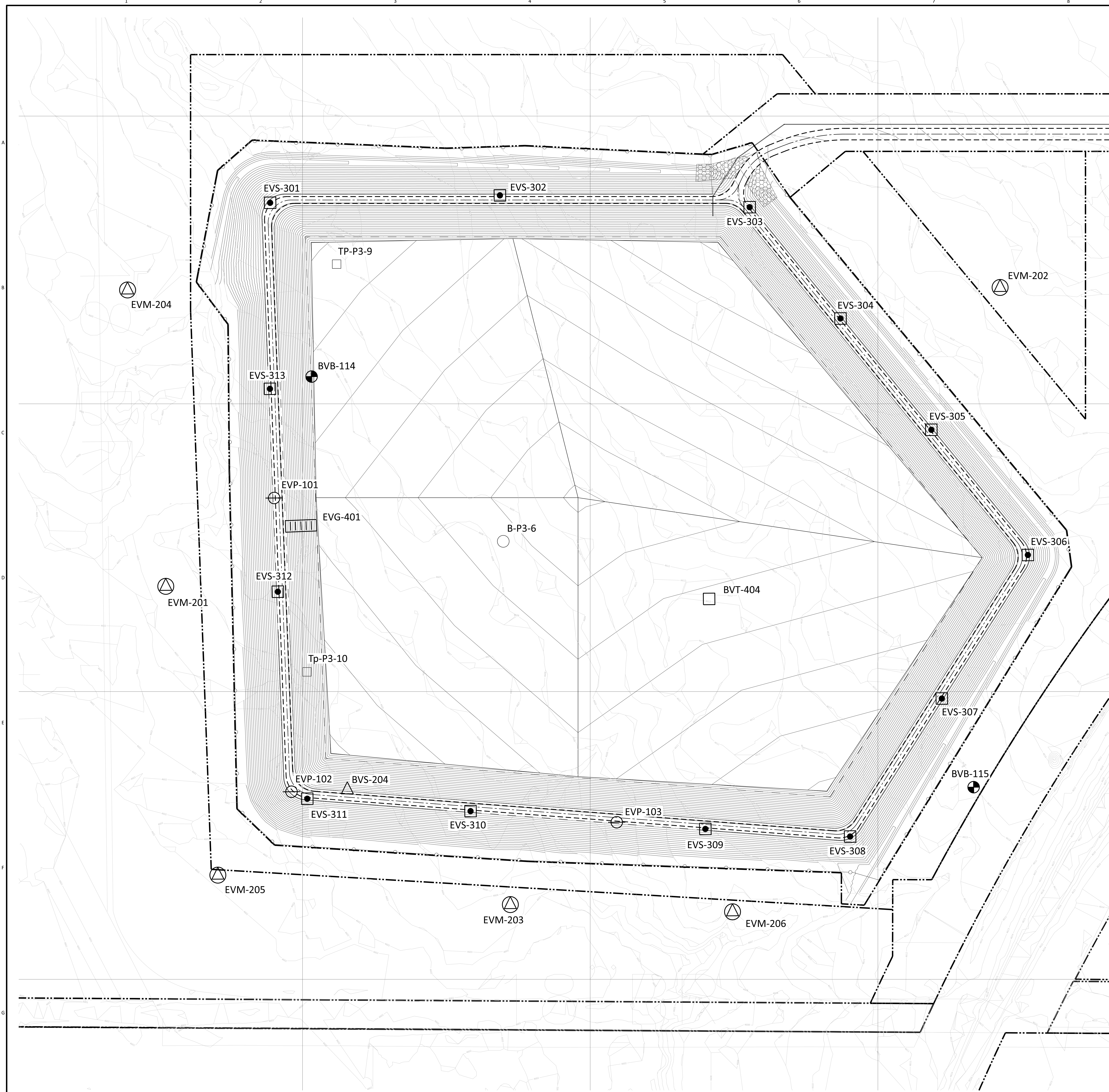

NOTES

- HORIZONTAL CONTROL IS BASED ON THE DUCHESS LOCAL GROUND COORDINATE SYSTEM, IN UNITS OF US SURVEY FEET, UNLESS NOTED OTHERWISE.
- VERTICAL CONTROL IS BASED ON NAVD88.

LEGEND

- BVB-XXX - EXISTING SOIL BORING
- BVS-XXX - EXISTING CONE PENETROMETER SOUNDING
- BVT-XXX - EXISTING TEST PIT
- EVP-1XX - NEW PIEZOMETER (SEE DWG S3911 FOR DETAILS)
- EVM-2XX - NEW MONITORING WELL (SEE DWG S3911 FOR DETAILS)
- EVS-XXX - EMBANKMENT SETTLEMENT MONUMENT (SEE DWG S3911 FOR DETAILS)
- EVG-4XX - RESERVOIR GAUGE MARKS (COORDINATE IN TABLE AT BOTTOM OF POND)
- PROPERTY LINE
- EXISTING CONTOUR (1 FT INTERVAL)
- NEW CONTOUR (2 FT INTERVAL)

EXISTING BORING / TEST PIT LOCATIONS

LOCATION	DEPTH	NORTHING (STATE PLANE)	EASTING (STATE PLANE)	EXISTING ELEVATION	LATITUDE	LONGITUDE
BVB-113	50.5	6982722.33	1330966.55	4625.4	39.4841292	-112.5964485
BVB-114	25.5	6982307.3	1329073.69	4607.6	39.4829259	-112.6031365
BVB-115	50.5	6981583.6	1330217.43	4613.6	39.4809777	-112.5990530
BVS-204	25.0	6981588.68	1329129.25	4603.1	39.4805549	-112.6029063
BVS-205	25.0	6982276.97	1330516.07	4621.1	39.4828914	-112.5980251
BVT-403	8.5	6982298.68	1330856.89	4621.8	39.4829624	-112.5968186
BVT-404	8.0	6981914.54	1329760.83	4611.3	39.4818709	-112.6006850
B-P3-6	100.5	N/A	N/A	4608.7	N/A	N/A
TP-P3-9	11.0	N/A	N/A	4609.7	N/A	N/A
TP-P3-10	11.5	N/A	N/A	4604.5	N/A	N/A

NEW INSTRUMENTATION LOCATIONS

LOCATION	NORTHING (STATE PLANE)	EASTING (STATE PLANE)	FINISHED ELEVATION
EVP-101	6982096.736	1329006.776	4624.3
EVP-102	6981586.239	1329032.250	4624.3
EVP-103	6981528.078	1329596.826	4624.3
EVM-201	6981945.017	1328817.051	4603.5
EVM-202	6982450.933	1330271.348	4620.5
EVM-203	6981386.741	1329410.664	4603.5
EVM-204	6982460.421	1328755.345	4606.0
EVM-205	6981442.544	1328902.954	4602.0
EVM-206	6981370.693	1329796.592	4608.0
EVS-301	6982609.561	1329004.405	4624.3
EVS-302	6982618.804	1329403.749	4624.3
EVS-303	6982594.313	1329837.51	4624.3
EVS-304	6982399.564	1329993.59	4624.3
EVS-305	6982204.814	1330149.649	4624.3
EVS-306	6981985.817	1330315.39	4624.3
EVS-307	6981737.813	1330163.593	4624.3
EVS-308	6981499.572	1330002.072	4624.3
EVS-309	6981514.978	1329750.665	4624.3
EVS-310	6981549.693	1329342.988	4624.3
EVS-311	6981573.832	1329059.512	4624.3
EVS-312	6981933.894	1329011.514	4624.3
EVS-313	6982286.451	1329021.139	4624.3
EVG-401	6982048.760	1329079.910	N/A

EXTENSIVE REVISIONS PER ECN N-S-0044

APPROVED FOR CONSTRUCTION

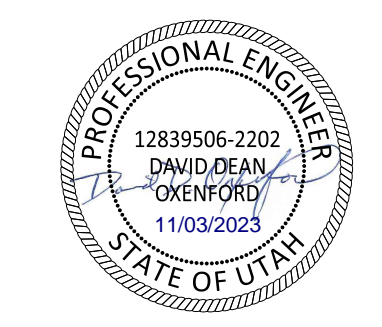

BLACK & VEATCH
 ADVANCED CLEAN ENERGY STORAGE I, LLC
 ACES PROJECT I
 EVAPORATION POND INSTRUMENTATION - PLAN
 PROJECT: 411943-10STF-S3011B
 DRAWING NUMBER: 1
 REV: 1

M:\CS\2023\11\02\2023\11-13 AM
 11/02/2023 11:13 AM
 11/02/2023 11:13 AM

NO	DATE	REVISIONS AND RECORD OF ISSUE	DRN	DES	CHK	PDE	APP
1	03/NOV/23	REVISED PER ECN N-S-0044					
0	07/JUL/23	ISSUED FOR CONSTRUCTION					

I HEREBY CERTIFY THAT THIS DOCUMENT WAS PREPARED BY ME OR UNDER MY DIRECT SUPERVISION AND THAT I AM A DULY REGISTERED PROFESSIONAL ENGINEER UNDER THE LAWS OF THE STATE OF UTAH.
 SIGNED: DAVID DEAN
 DATE: 07/JUL/23 REG. NO.: 128906-2202

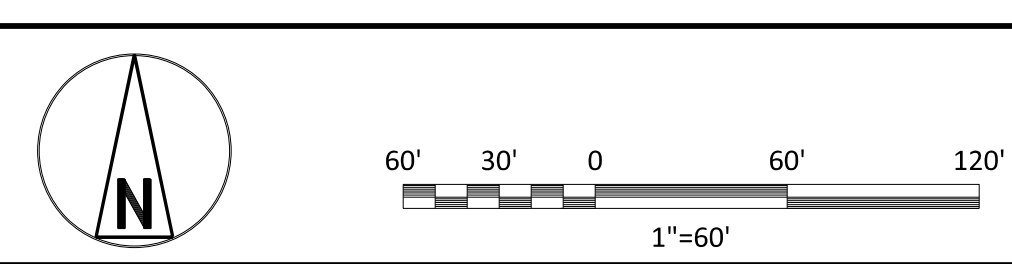

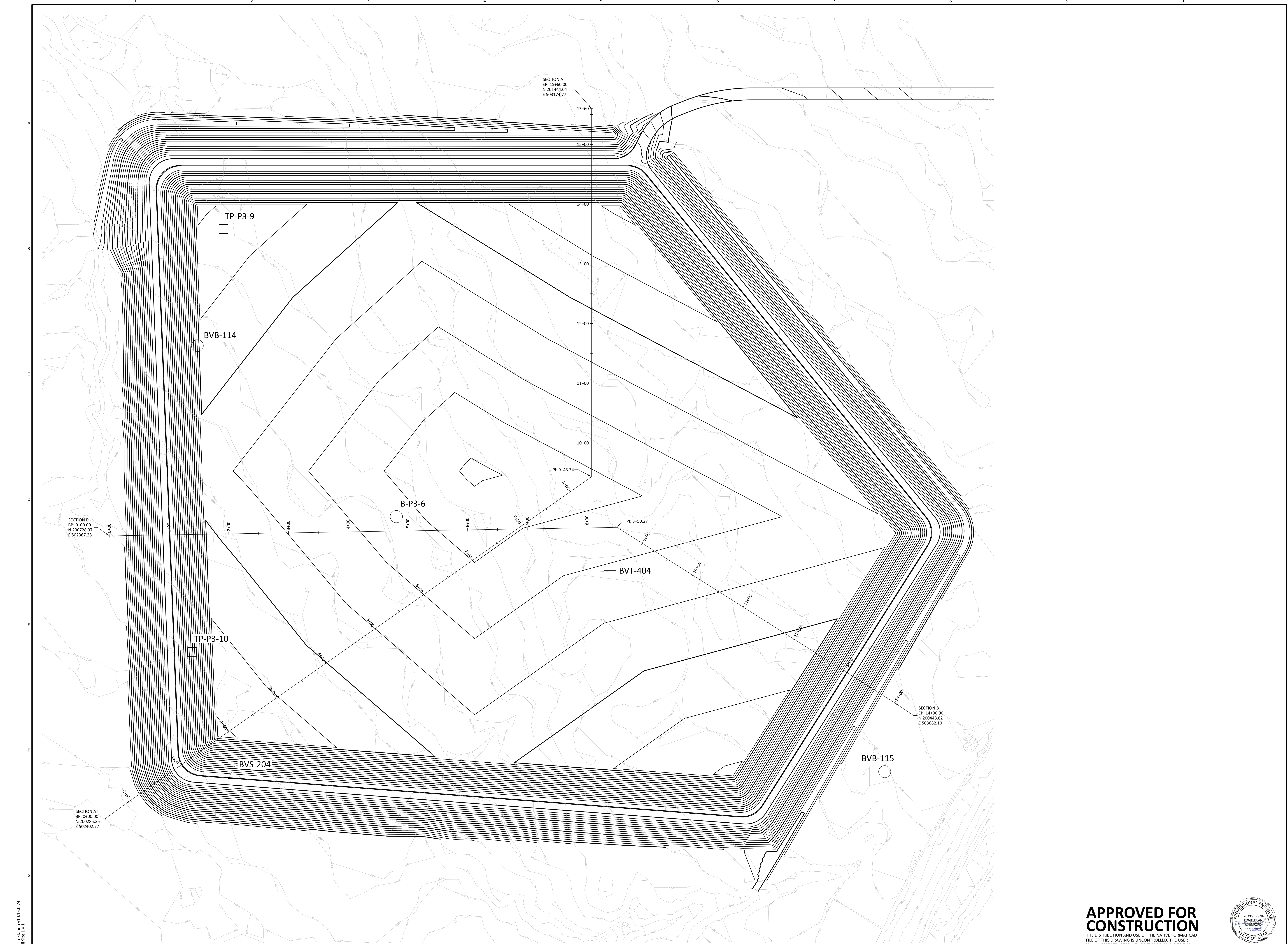

SECTION A
 EP: 15+60.00
 N 201444.04
 E 503174.77

SECTION B
 BP: 0+00.00
 N 200728.37
 E 502367.28

SECTION B
 EP: 14+00.00
 N 200448.82
 E 503662.10

SECTION A
 BP: 0+00.00
 N 200285.25
 E 502402.77

11/02/2023 03:19 PM
 11/02/2023 03:19 PM
 11/02/2023 03:19 PM

NO	DATE	ISSUED FOR CONSTRUCTION	REVISIONS AND RECORD OF ISSUE
0	03/NOV/23	ISSUED FOR CONSTRUCTION	

I HEREBY CERTIFY THAT THIS DOCUMENT WAS PREPARED BY ME OR UNDER MY DIRECT SUPERVISION AND THAT I AM A DULY REGISTERED PROFESSIONAL ENGINEER UNDER THE LAWS OF THE STATE OF UTAH.
 SIGNED: *David Dean Orendorf*
 DATE: 03/NOV/23 REG. NO.: 12839506-2202

APPROVED FOR CONSTRUCTION
 THE DISTRIBUTION AND USE OF THE NATIVE FORMAT CAD FILE OF THIS DRAWING IS UNCONTROLLED. THE USER SHALL VERIFY TRACEABILITY OF THIS DRAWING TO THE LATEST CONTROLLED VERSION.

ADVANCED CLEAN ENERGY STORAGE I, LLC
 ACES PROJECT I
 EVAPORATION POND - SITE SECTIONS PLAN VIEW

PROJECT: 411943-10STF-S3050
 DRAWING NUMBER: 0
 REV: 0

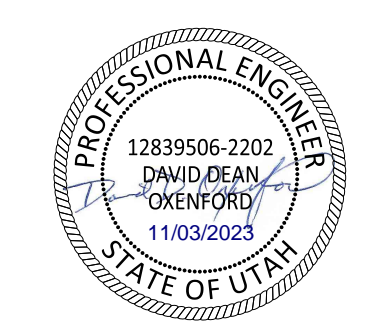

Lithology Graphics

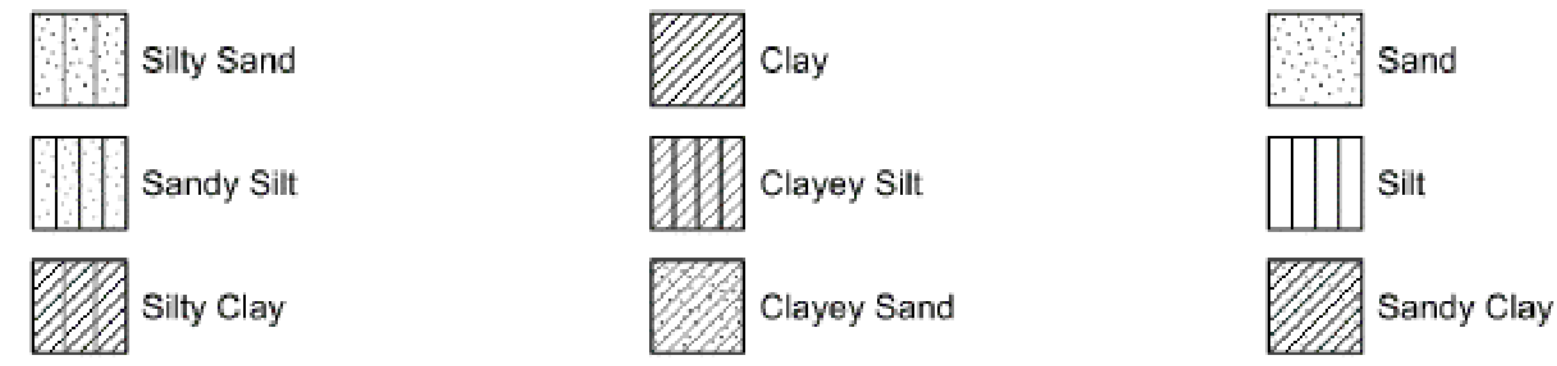

Sampler Graphics

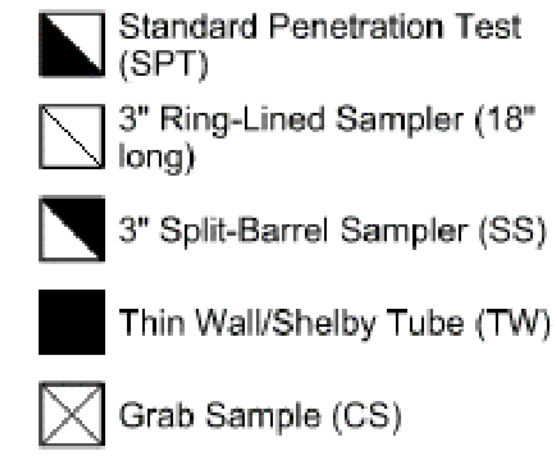

B-P3-06 Borehole Number

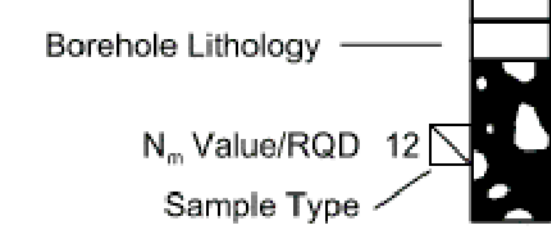

q_c CPT Cone Tip Resistance
 R_f CPT Friction Ratio
 u_2 CPT Generated Pore Pressure

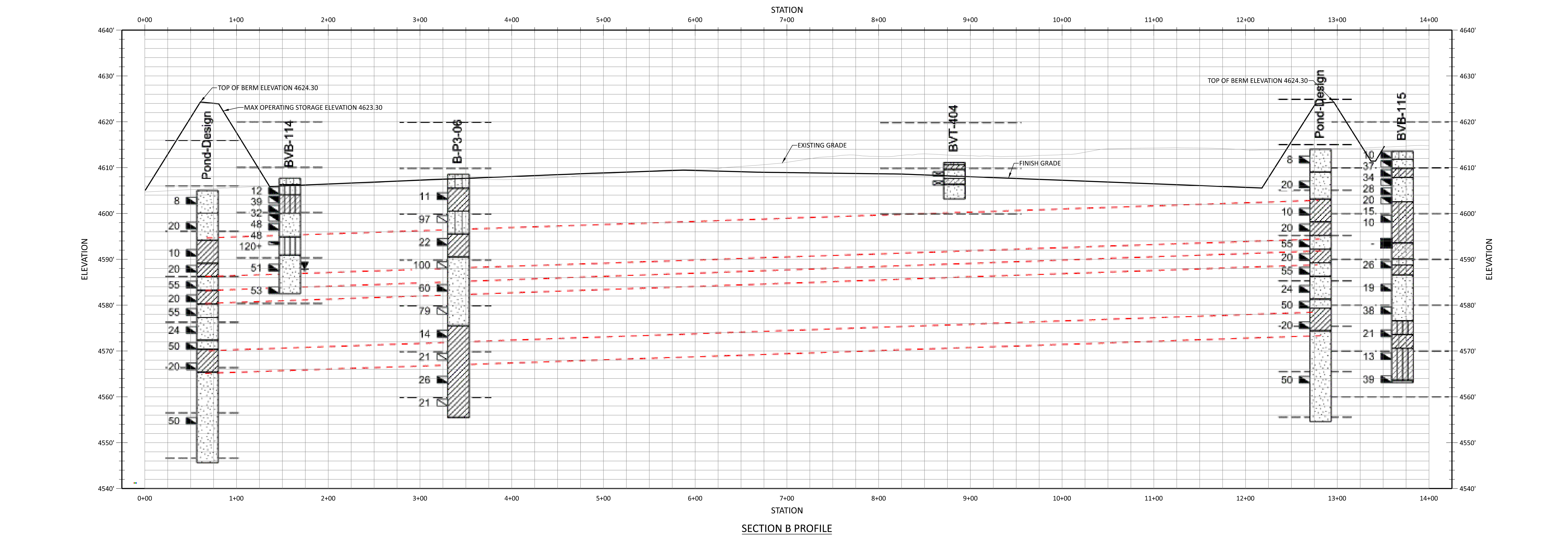
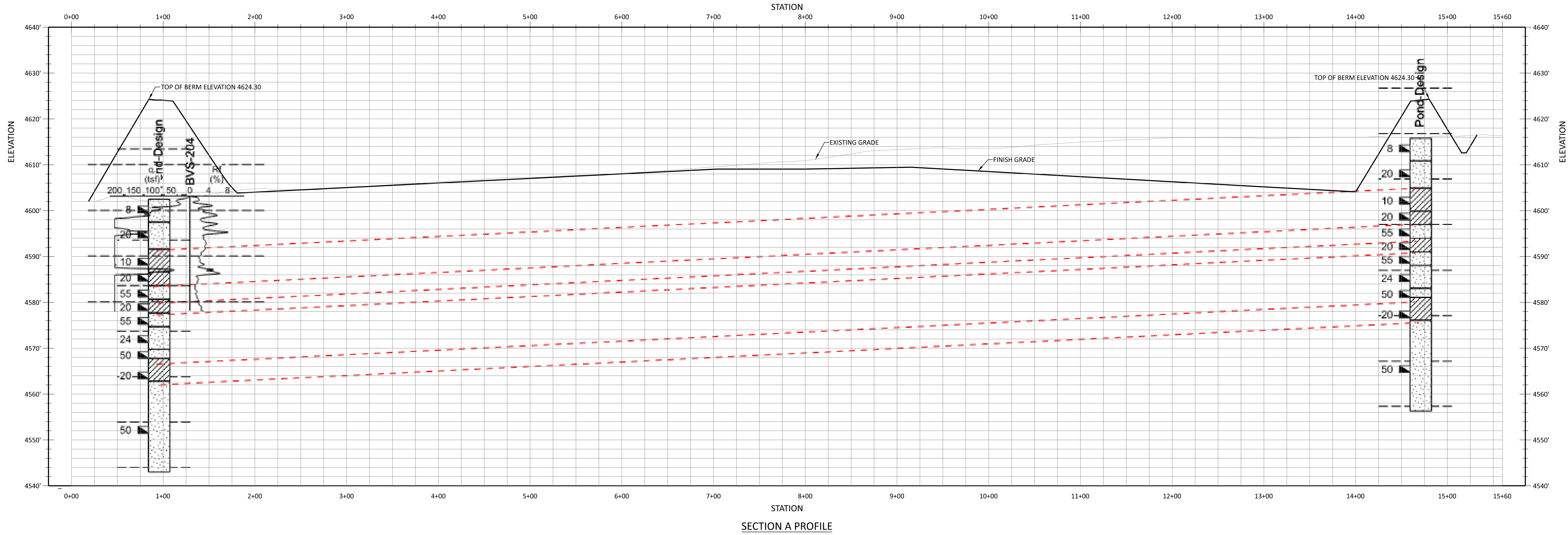

11/02/2023 11:27 AM
 11/02/2023 11:27 AM
 11/02/2023 11:27 AM

NO	DATE	REVISIONS AND RECORD OF ISSUE
0	03/NOV/23	ISSUED FOR CONSTRUCTION

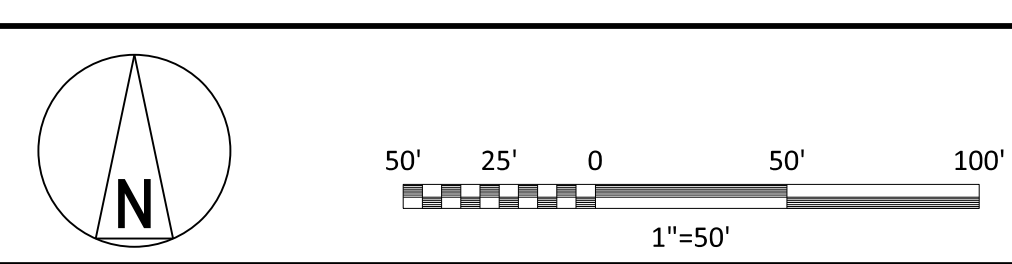

I HEREBY CERTIFY THAT THIS DOCUMENT WAS PREPARED BY ME OR UNDER MY DIRECT SUPERVISION AND THAT I AM A DULY REGISTERED PROFESSIONAL ENGINEER UNDER THE LAWS OF THE STATE OF UTAH.

SIGNED: DAVID DEAN ORENFORD
 DATE: 03/NOV/23 REG NO: 12839506-2202

BLACK & VEATCH

DESIGNER: MTS DRAWN: MTS
 CHECKED: CAF DATE: 03/NOV/23

APPROVED FOR CONSTRUCTION

THE DISTRIBUTION AND USE OF THE NATIVE FORMAT CAD FILE OF THIS DRAWING IS UNCONTROLLED. THE USER SHALL VERIFY TRACEABILITY OF THIS DRAWING TO THE LATEST CONTROLLED VERSION.

ADVANCED CLEAN ENERGY STORAGE I, LLC
 ACES PROJECT I
 EVAPORATION POND - SITE SECTIONS PROFILE VIEW

PROJECT DRAWING NUMBER: 411943-10STF-S3051
 REV: 0

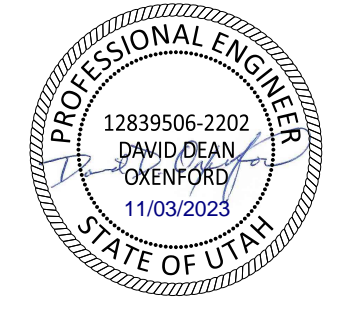

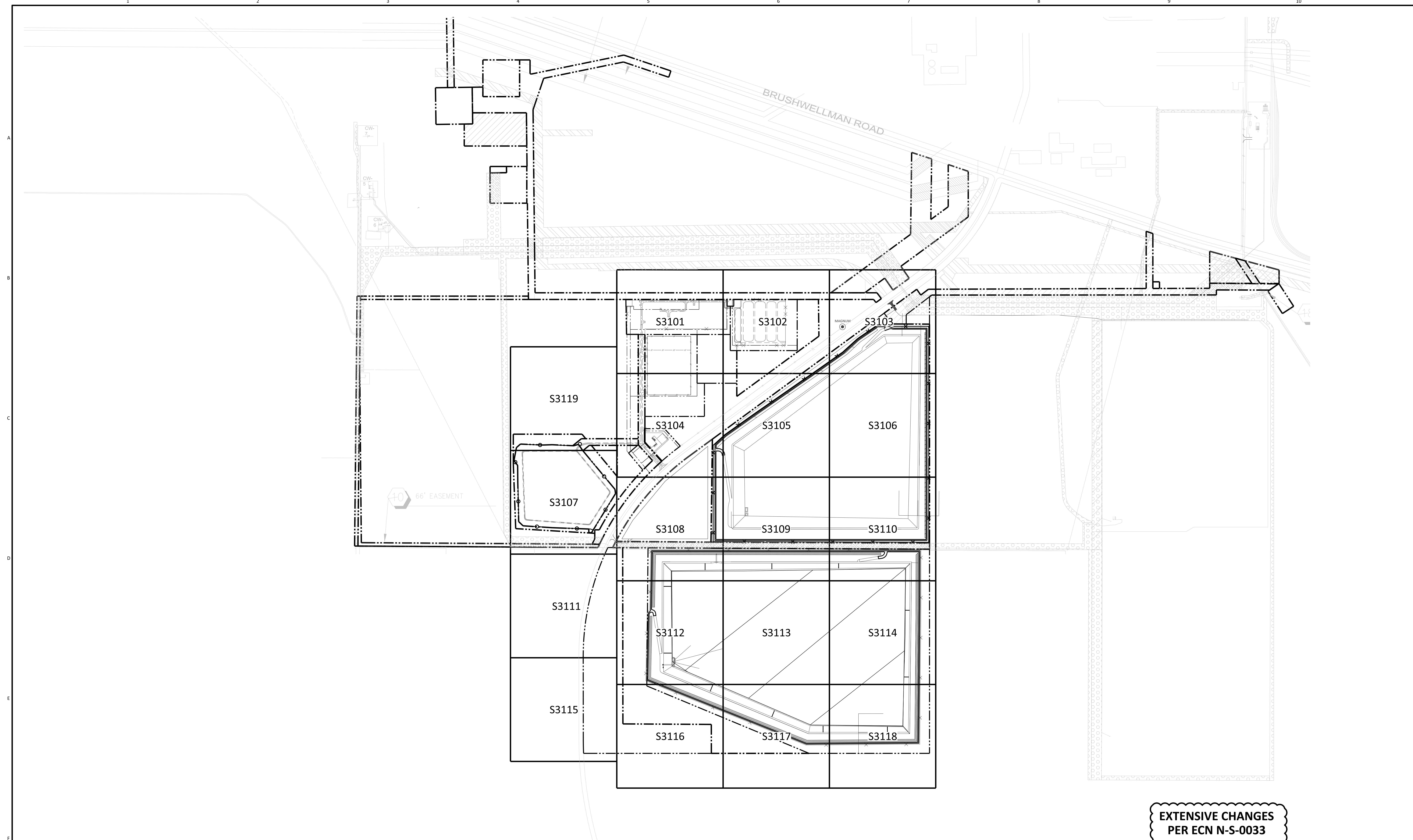

**EXTENSIVE CHANGES
PER ECN N-S-0033**

TEMPORARY VEGETATIVE COVER

- GENERAL:
- DISTURBED AREAS SHALL BE STABILIZED WITHIN 14 DAYS AFTER CONSTRUCTION ACTIVITY HAS TEMPORARILY OR PERMANENTLY CEASED, WITH TWO EXCEPTIONS: WHEN SNOW COVER PRECLUDES CONSTRUCTION OR WHEN CONSTRUCTION WILL RESUME WITHIN 21 DAYS.
- SITE PREPARATION:
- INSTALL REQUIRED SURFACE WATER CONTROL MEASURES.
 - REMOVE LOOSE ROCK, STONE, AND CONSTRUCTION DEBRIS FROM AREA.
 - TILLAGE SHOULD ACHIEVE A REASONABLY UNIFORM LOOSE SEEDBED. WORK ON CONTOUR IF SITE IS SLOPING.
- ESTABLISHMENT:
- SELECT APPROPRIATE SPECIES FOR THE SITUATION. NOTE RATES AND SEEDING DATES AS SPECIFIED BY SEEDING SUPPLIER.
 - APPLY SEED UNIFORMLY ACCORDING TO THE RATE INDICATED BY BROADCASTING, DRILLING, OR HYDRAULIC APPLICATION.
 - UNLESS HYDROSEEDING, COVER SEEDS WITH NOT MORE THAN 1/4 INCH OF SOIL USING SUITABLE EQUIPMENT.
 - MULCH IMMEDIATELY AFTER SEEDING AS REQUIRED. APPLY STRAW OR HAY MULCH AND ANCHOR TO SLOPES GREATER THAN 3% OR WHERE CONCENTRATED FLOW WILL OCCUR.

PERMANENT VEGETATIVE COVER

- PERMANENT VEGETATIVE COVER SHALL BE IN ACCORDANCE WITH THE UDOT 2022 STANDARD SPECIFICATIONS FOR ROAD AND BRIDGE CONSTRUCTION, SECTION 02922 SEED, TURF SEED AND TURF SOD.
- EROSION CHECKS**
- TEMPORARY PERVIOUS BARRIERS USING RIPRAP OR SILT FENCE SHALL BE INSTALLED AND MAINTAINED AS REQUIRED TO CHECK EROSION AND REDUCE SEDIMENTATION IN AREAS DEEMED APPROPRIATE DURING CONSTRUCTION.
 - INLET PROTECTION MEASURES SHALL BE INSTALLED AT ALL CULVERT AND DRAIN INLETS, AND WHERE INDICATED ON PLAN DRAWINGS.
 - ALL EROSION CHECKS SHALL BE MAINTAINED UNTIL ADJACENT AREAS ARE STABILIZED.
- SEDIMENT & EROSION CONTROL PLAN NOTES:**
- GENERAL:
- THESE GUIDELINES SHALL APPLY TO ALL WORK CONSISTING OF ANY AND ALL TEMPORARY AND/OR PERMANENT MEASURES TO CONTROL WATER POLLUTION AND SOIL EROSION, AS MAY BE REQUIRED, DURING THE CONSTRUCTION OF THE PROJECT.
 - IN GENERAL, ALL CONSTRUCTION ACTIVITIES SHALL PROCEED IN SUCH A MANNER SO AS NOT TO POLLUTE ANY WETLANDS, WATERCOURSE, WATERBODY, AND CONDUIT CARRYING WATER, ETC. THE CONTRACTOR SHALL LIMIT, INsofar AS POSSIBLE, THE SURFACE AREA OF EARTH MATERIALS EXPOSED BY CONSTRUCTION METHODS, AND IMMEDIATELY PROVIDE PERMANENT AND TEMPORARY POLLUTION CONTROL MEASURES TO PREVENT CONTAMINATION OF ADJACENT WETLANDS, WATERCOURSES, AND WATERBODIES, AND TO PREVENT, INsofar AS POSSIBLE, EROSION ON THE SITE.
 - BEST MANAGEMENT PRACTICES FOR EROSION CONTROL SHALL BE IMPLEMENTED AND MAINTAINED AT ALL TIMES DURING CONSTRUCTION TO PREVENT SILTATION AND TURBID DISCHARGES. METHODS SHALL INCLUDE, BUT ARE NOT LIMITED TO THE USE OF STAKED HAY BALES, STAKED FILTER CLOTH, SODDING, SEEDING, AND MULCHING AND STAGED CONSTRUCTION.

STABILIZED CONSTRUCTION ENTRANCE

- GENERAL:
- PRIOR TO ANY REGRADING, A STABILIZED CONSTRUCTION ENTRANCE SHALL BE PLACED AT THE ENTRANCE TO THE WORK AREA IN ORDER TO REDUCE MUD AND OTHER SEDIMENTS FROM LEAVING THE SITE.
- REFERENCES:
- SEE THE S3000 SERIES DRAWINGS FOR FINISHED GRADING AND DRAINAGE OF THE HYDROGEN PRODUCTION FACILITY. SEE DRAWINGS S3200-S32XX FOR FINISHED SURFACING OF THE HYDROGEN PRODUCTION FACILITY.

LEGEND

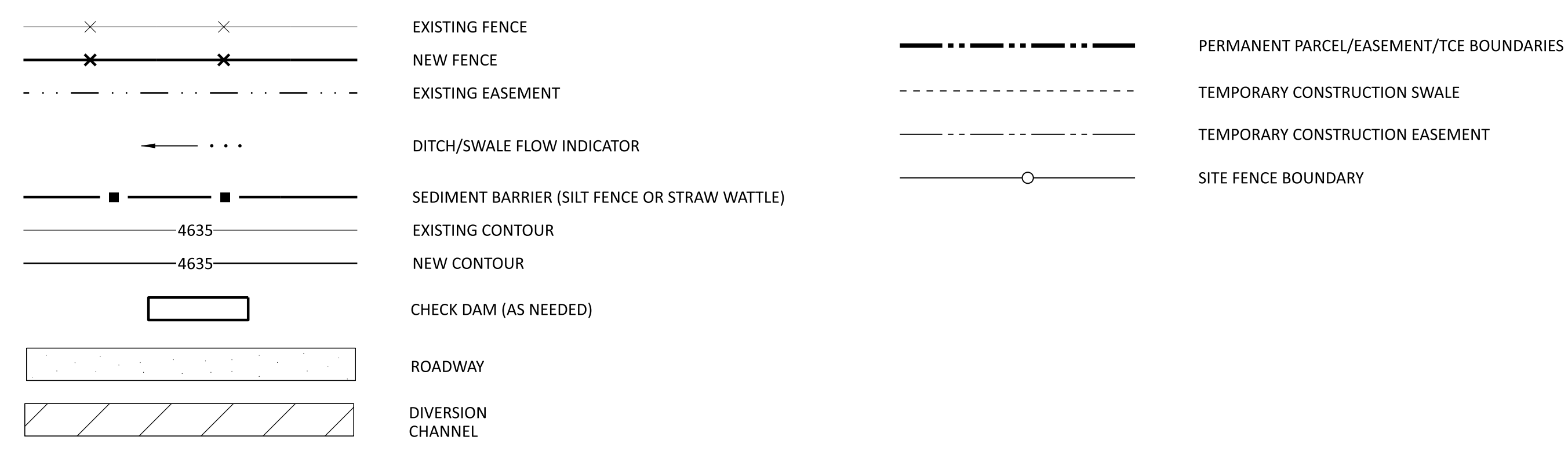

SHEET 0006
 08/08/2023 09:57 AM
 PROJECT: 288048-1STE-S3100
 DATE: 18/MAR/22

NO	DATE	REVISIONS AND RECORD OF ISSUE
2	08/AUG/23	REVISED PER ECN N-S-0033
1	27/FEB/23	REVISED PER ECN N-S-0008
0	24/MAR/22	APPROVED FOR CONSTRUCTION

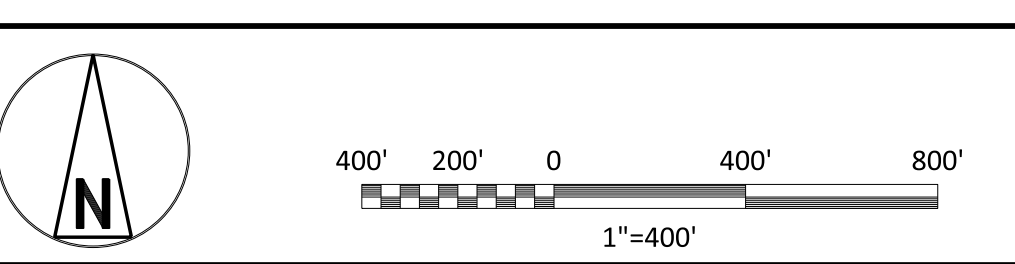

I HEREBY CERTIFY THAT THIS DOCUMENT WAS PREPARED BY ME OR UNDER MY DIRECT SUPERVISION AND THAT I AM A DULY REGISTERED PROFESSIONAL ENGINEER UNDER THE LAWS OF THE STATE OF UTAH.

SIGNED: STEPHANIE KEY HALL
 DATE: 18/MAR/22 REG. NO.: 11898456

BLACK & VEATCH

DESIGNER: ME DRAWN: JKH
 CHECKED: CAF DATE: 18/MAR/22

ADVANCED CLEAN ENERGY STORAGE I, LLC
 ACES PROJECT I
 EROSION CONTROL - SITE
 KEY PLAN, GENERAL NOTES AND LEGEND

PROJECT: 288048-1STE-S3100
 DRAWING NUMBER: 2
 REV: 2

APPROVED FOR CONSTRUCTION

THE DISTRIBUTION AND USE OF THE NATIVE FORMAT CAD FILE OF THIS DRAWING IS UNCONTROLLED. THE USER SHALL VERIFY TRACEABILITY OF THIS DRAWING TO THE LATEST CONTROLLED VERSION.

- 1. SEE DRAWING S3100 FOR KEY PLAN, GENERAL NOTES AND LEGEND.
- 2. SEE DRAWING S3920 FOR TYPICAL EROSION CONTROL DETAILS.
- 3. ROCK CHECK FILTER DAMS SHALL BE INSTALLED AT LOCATIONS AND SPACING DETERMINED IN THE FIELD TO PREVENT SEDIMENT TRANSPORT.

**EXTENSIVE REVISIONS
PER ECN N-S-0044**

KEY PLAN

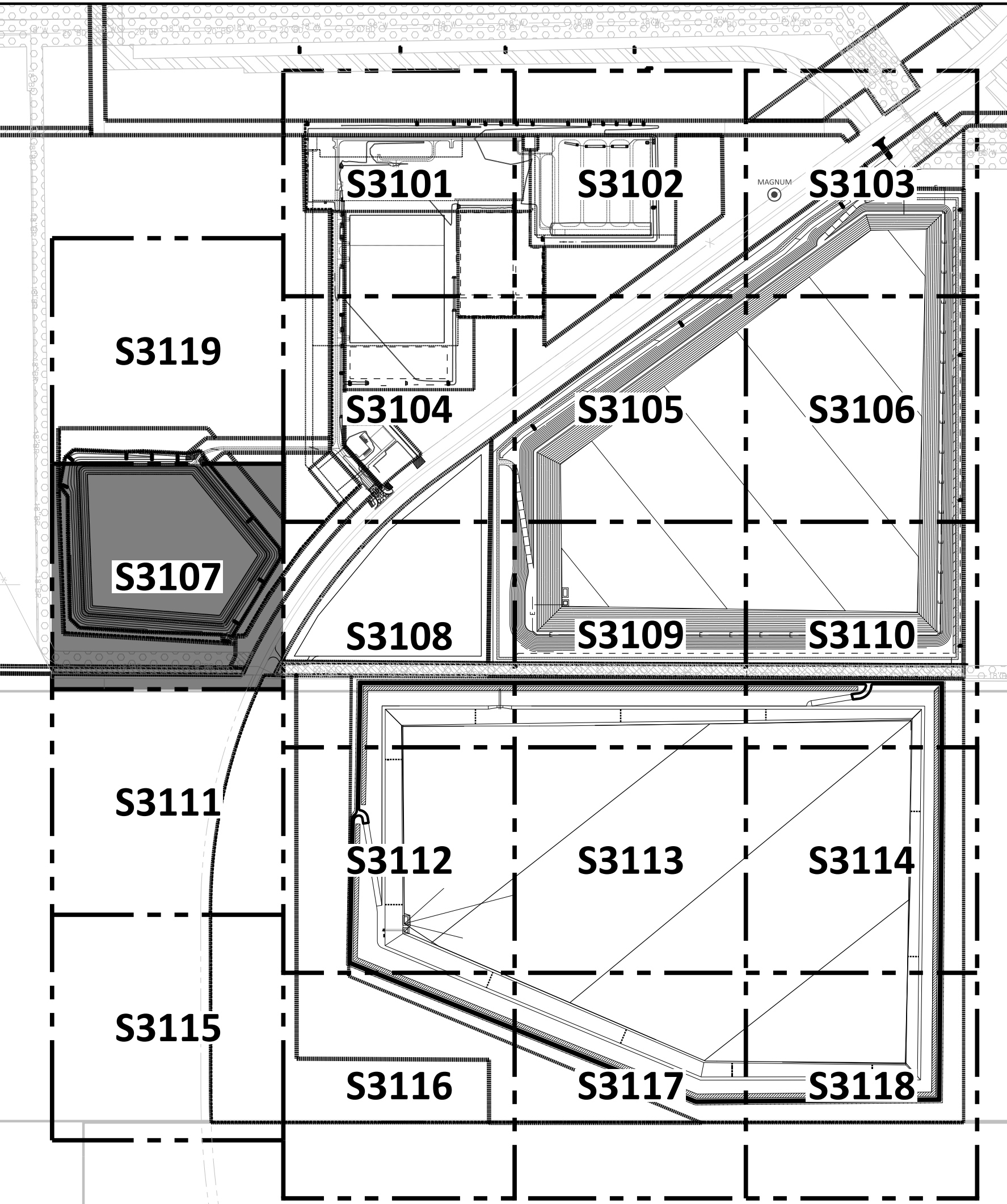

**APPROVED FOR
CONSTRUCTION**

THE DISTRIBUTION AND USE OF THE NATIVE FORMAT CAD FILE OF THIS DRAWING IS UNCONTROLLED. THE USER SHALL VERIFY TRACEABILITY OF THIS DRAWING TO THE LATEST CONTROLLED VERSION.

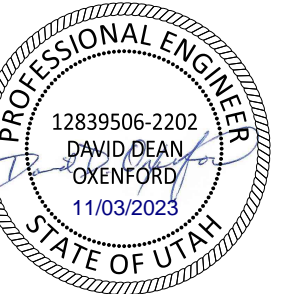

PROJECT		DRAWING NUMBER		REV	
ADVANCED CLEAN ENERGY STORAGE I, LLC		288048-1STE-S3107		2	
ACES PROJECT I		CODE			
EROSION CONTROL - SITE		AREA			
PLAN - AREA 7					

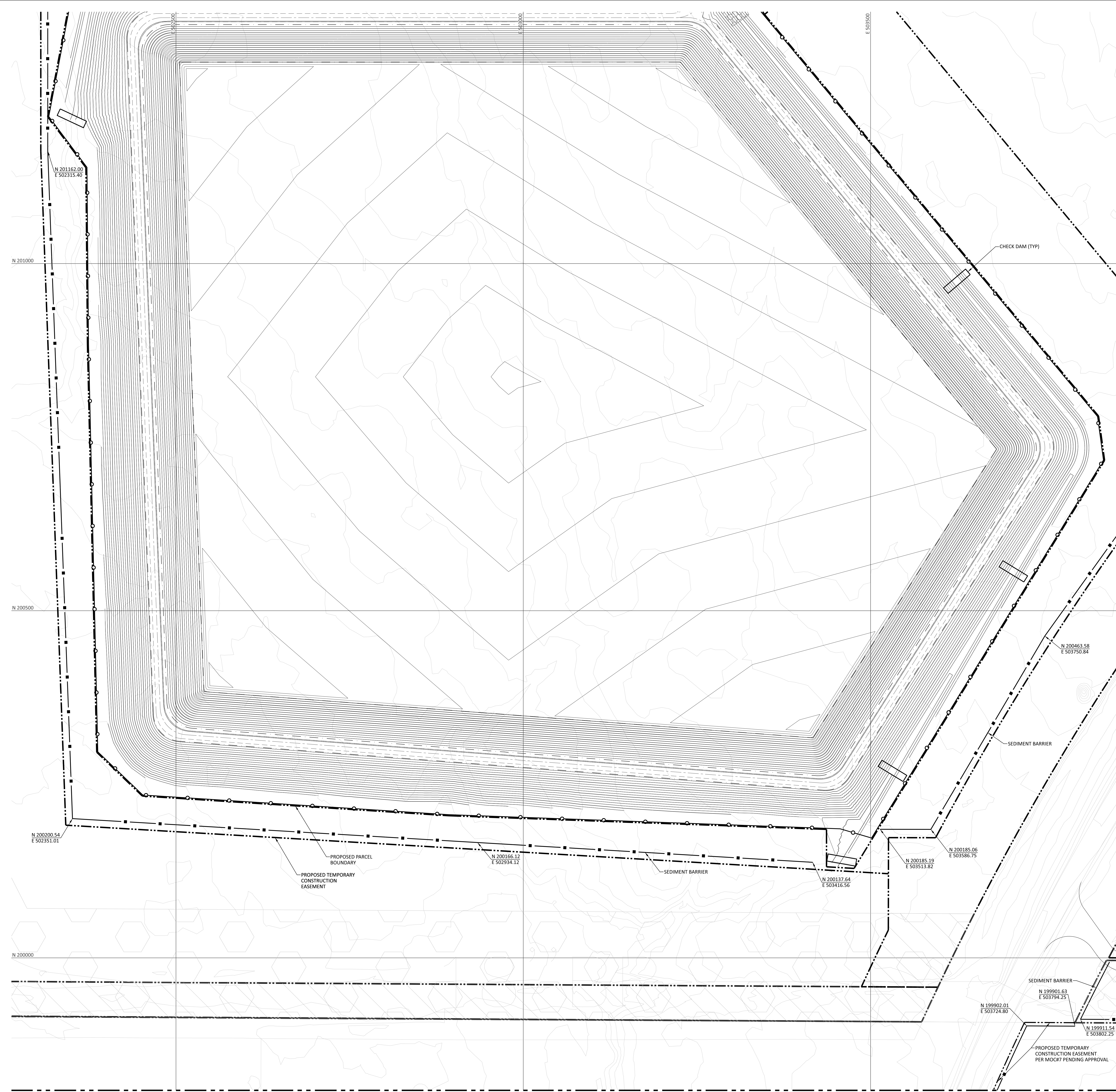

MATCHLINE - FOR CONTINUATION SEE S3111

MATCHLINE - FOR CONTINUATION SEE S3104

MATCHLINE - FOR CONTINUATION SEE S3108

NO	DATE	REVISIONS AND RECORD OF ISSUE	DRN	DES	CHK	PDE	APP
2	03/NOV/23	REVISED PER ECN N-S-0044	MTS	MTS	CAF	DDO	CIG
1	08/AUG/23	REVISED PER ECN N-S-0033	MTS	GDV	CAF	DDO	CIG
0	27/FEB/23	ISSUED FOR CONSTRUCTION	JDF	RRY	CAF	DDO	CIG

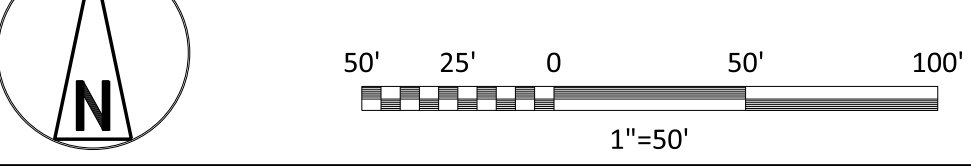
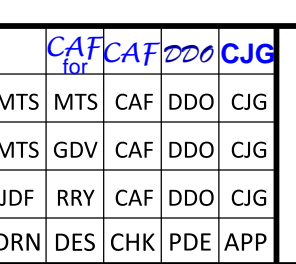

I HEREBY CERTIFY THAT THIS DOCUMENT WAS PREPARED BY ME OR UNDER MY DIRECT SUPERVISION AND THAT I AM A DULY REGISTERED PROFESSIONAL ENGINEER UNDER THE LAWS OF THE STATE OF UTAH.

SIGNED: DAVID DEAN OKENFORD
DATE: 27/FEB/23 REG NO: 1289906-2202

BLACK & VEATCH

DESIGNER	RY	DRAWN	JDF
CHECKED	CAF	DATE	27/FEB/23

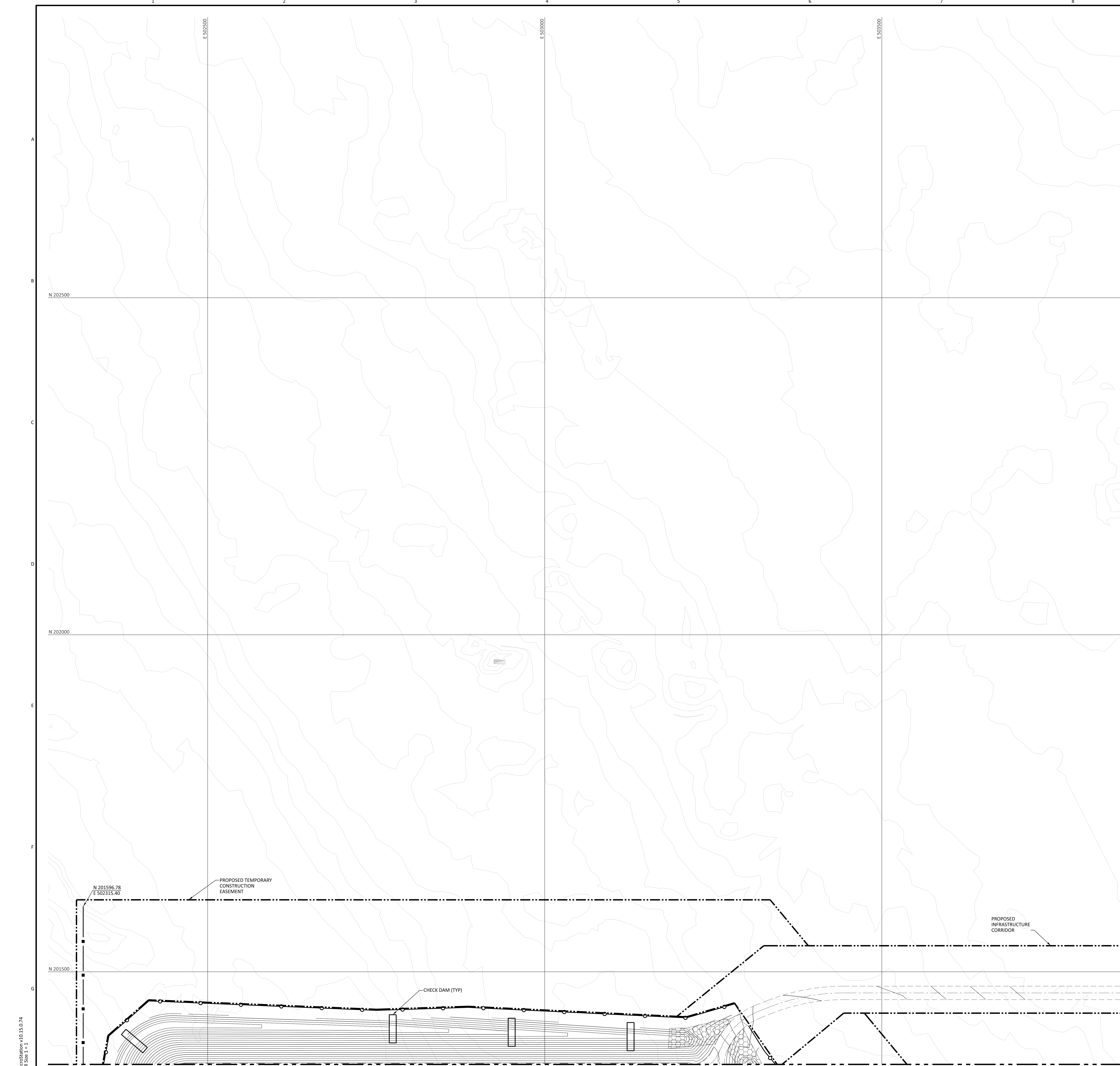

- NOTES**
- SEE DRAWING S3100 FOR KEY PLAN, GENERAL NOTES AND LEGEND.
 - SEE DRAWING S3920 FOR TYPICAL EROSION CONTROL DETAILS.
 - ROCK CHECK FILTER DAMS SHALL BE INSTALLED AT LOCATIONS AND SPACING DETERMINED IN THE FIELD TO PREVENT SEDIMENT TRANSPORT.

**EXTENSIVE REVISIONS
PER ECN N-S-0044**

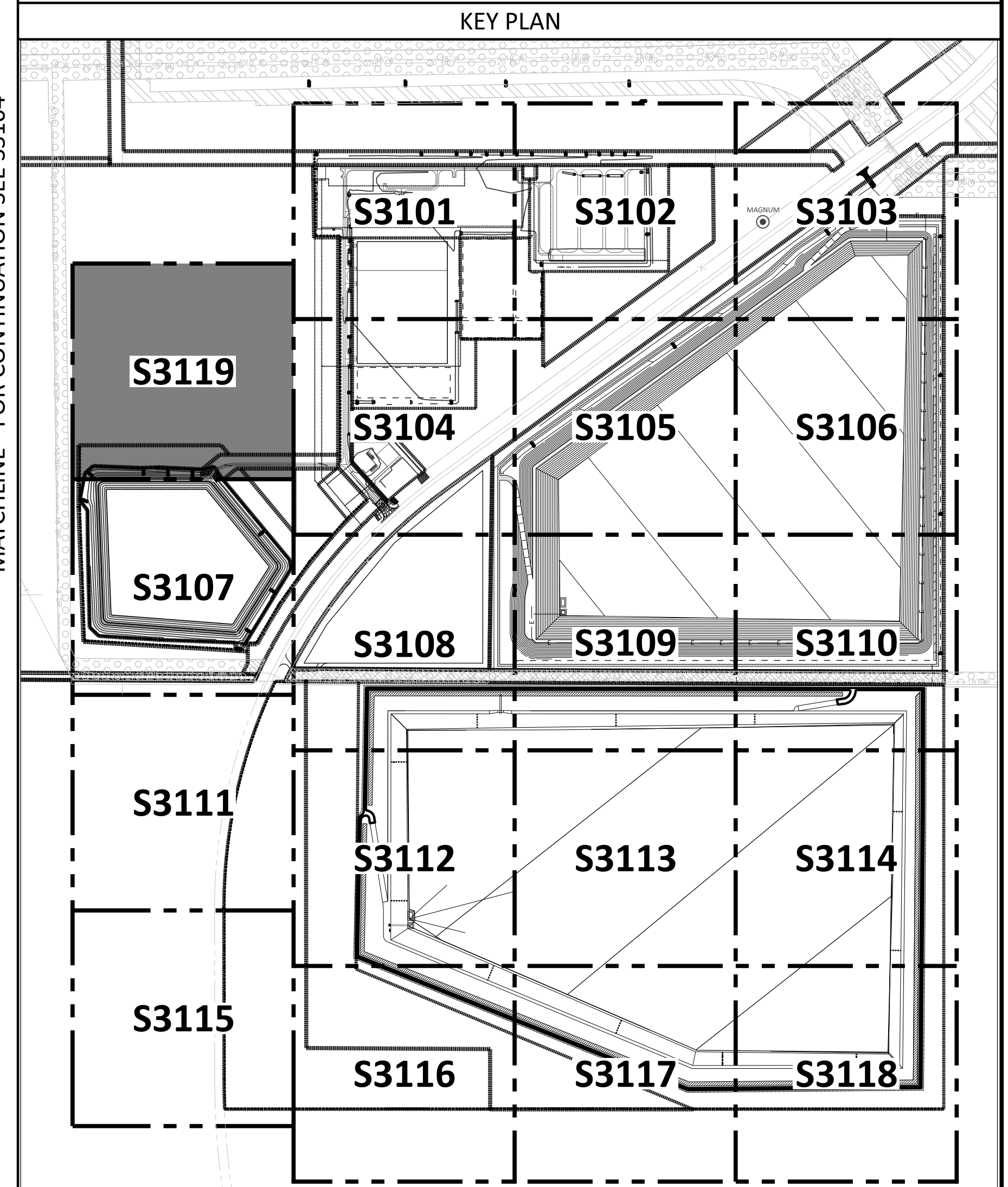

Small 16.006
 10/23/2023 04:09 PM
 MTS/DESIGN/VDL15.074
 10/23/2023 04:09 PM

MATCHLINE - FOR CONTINUATION SEE S3107

NO	DATE	REVISIONS AND RECORD OF ISSUE	DRN	DES	CHK	PDE	APP
1	03/NOV/23	REVISED PER ECN N-S-0044	MTS	MTS	CAF	DDO	CG
0	08/AUG/23	ADDED PER ECN N-S-0033	MTS	GDV	CAF	DDO	CG

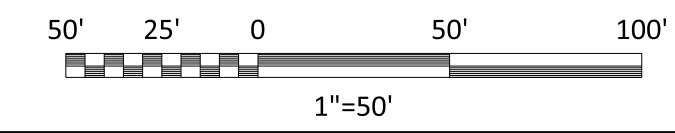
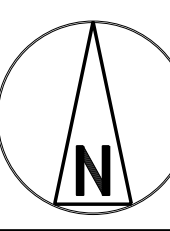

I HEREBY CERTIFY THAT THIS DOCUMENT WAS PREPARED BY ME OR UNDER MY DIRECT SUPERVISION AND THAT I AM A DULY REGISTERED PROFESSIONAL ENGINEER UNDER THE LAWS OF THE STATE OF UTAH

SIGNED: 09/AUG/23 DAVID DEAN OIKENFORD REG NO: 12839506-2202

BLACK & VEATCH

DESIGNER: JDE DRAWN: MTS
 CHECKED: CAF DATE: 09/AUG/23

APPROVED FOR CONSTRUCTION

THE DISTRIBUTION AND USE OF THE NATIVE FORMAT CAD FILE OF THIS DRAWING IS UNCONTROLLED. THE USER SHALL VERIFY TRACEABILITY OF THIS DRAWING TO THE LATEST CONTROLLED VERSION.

ADVANCED CLEAN ENERGY STORAGE I, LLC
 ACES PROJECT I
 EROSION CONTROL - SITE
 PLAN - AREA 19

PROJECT: 288048-1STE-S3119
 DRAWING NUMBER: 1
 REV: 1

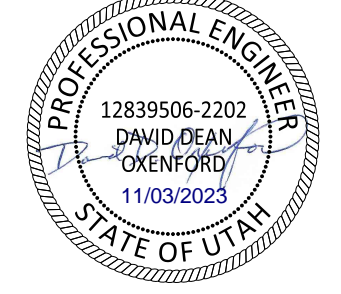

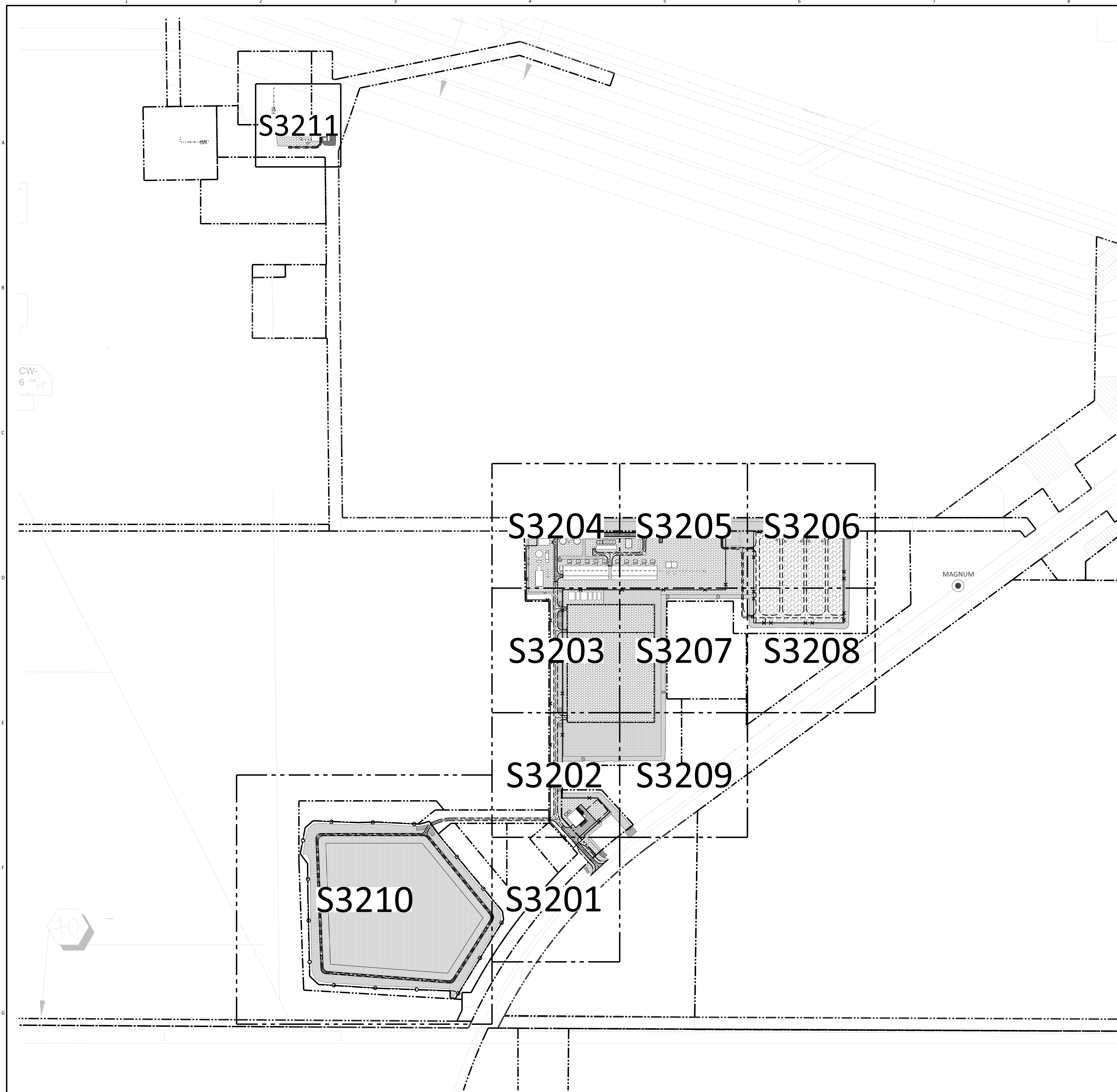

GENERAL NOTES
APPLICABLE TO ALL S3200 SERIES DRAWINGS

1. SEE THE E2500 SERIES DRAWINGS FOR FENCE GROUNDING.
2. THESE DRAWINGS SHOW THE FINISHED SURFACING MATERIAL. SEE THE S3000 SERIES DRAWINGS FOR FINISHED GRADING CONTOURS AND DETAILS. CONTOURS SHOWN ON THESE DRAWINGS ARE FOR REFERENCE ONLY AND SHOULD NOT BE USED FOR CONSTRUCTION.
3. SEE THE SECTIONS AND DETAILS ON DRAWING S3910 FOR SURFACING LAYER THICKNESSES.
4. SEE THE S3800 SERIES DRAWINGS FOR TEMPORARY CONSTRUCTION FENCING.
5. SEE DRAWING S3915 FOR TYPICAL FENCING DETAILS.

LEGEND
APPLICABLE TO ALL S3200 SERIES DRAWINGS

	SECURITY FENCE		ASPHALT ROADS AND PARKING
	SWITCHYARD FENCE		AGGREGATE ROADS
	TEMP CONSTRUCTION FENCE		GENERAL AGGREGATE
	FENCE BY OTHERS		SWITCHYARD AGGREGATE
	EXISTING FENCE		NATIVE SOIL
	DOUBLE SWING GATE		SIDEWALK
	PERSONEL GATE		RIPRAP
	SLIDE GATE		
	EXISTING/NEW CONTOURS		

**EXTENSIVE REVISIONS
PER ECN N-S-0044**

**APPROVED FOR
CONSTRUCTION**

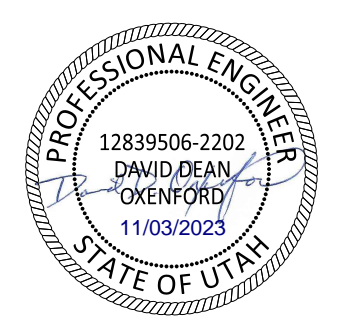

I HEREBY CERTIFY THAT THIS DOCUMENT WAS PREPARED BY ME OR UNDER MY DIRECT SUPERVISION AND THAT I AM A DULY REGISTERED PROFESSIONAL ENGINEER UNDER THE LAWS OF THE STATE OF UTAH.

SIGNED: DAVID DEAN OKENFORD
DATE: 21/SEP/22 REG. NO.: 12839506-2202

BLACK & VEATCH

DESIGNER: CAP DRAWN: MTS
CHECKED: FA DATE: 21/SEP/22

PROJECT	ADVANCED CLEAN ENERGY STORAGE I, LLC	DRAWING NUMBER	411943-10STD-S3200	REV	1
ACES PROJECT I					
FENCING & SURFACING - SITE KEY PLAN, GENERAL NOTES, & LEGEND					
CODE					
AREA					

NO	DATE	REVISIONS AND RECORD OF ISSUE	DRN	DES	CHK	PDE	APP
1	02/NOV/23	REVISED PER ECN N-S-0044	MTS	MTS	CAF	DDO	CGJ
0	19/SEP/22	ISSUED FOR CONSTRUCTION	MTS	CAF	FA	DDO	CGJ

Small Scale
 10/27/2023 04:15 PM
 MTS/CAF/DDO/CGJ
 411943-10STD-S3200

- SEE DRAWING S3200 FOR GENERAL NOTES AND LEGEND.
- FINAL STABILIZATION OF EXTERIOR EMBANKMENT SLOPES IS MET WHEN CONSTRUCTION, FINAL GRADE AND COMPACTION ARE VERIFIED AND TESTED PER THE ASSOCIATED EARTHWORKS TECHNICAL SPECIFICATION.
- THE LINER SYSTEM CONSISTS OF AGRU AMERICA HDPE 60 MIL MATERIAL. HDPE 60 MIL SMOOTH LINER SHALL BE PLACED ON POND BOTTOM SURFACE, AND HDPE 60 MIL MICROSPIKE LINER SHALL BE PLACED ON INTERIOR EMBANKMENT SLOPES.

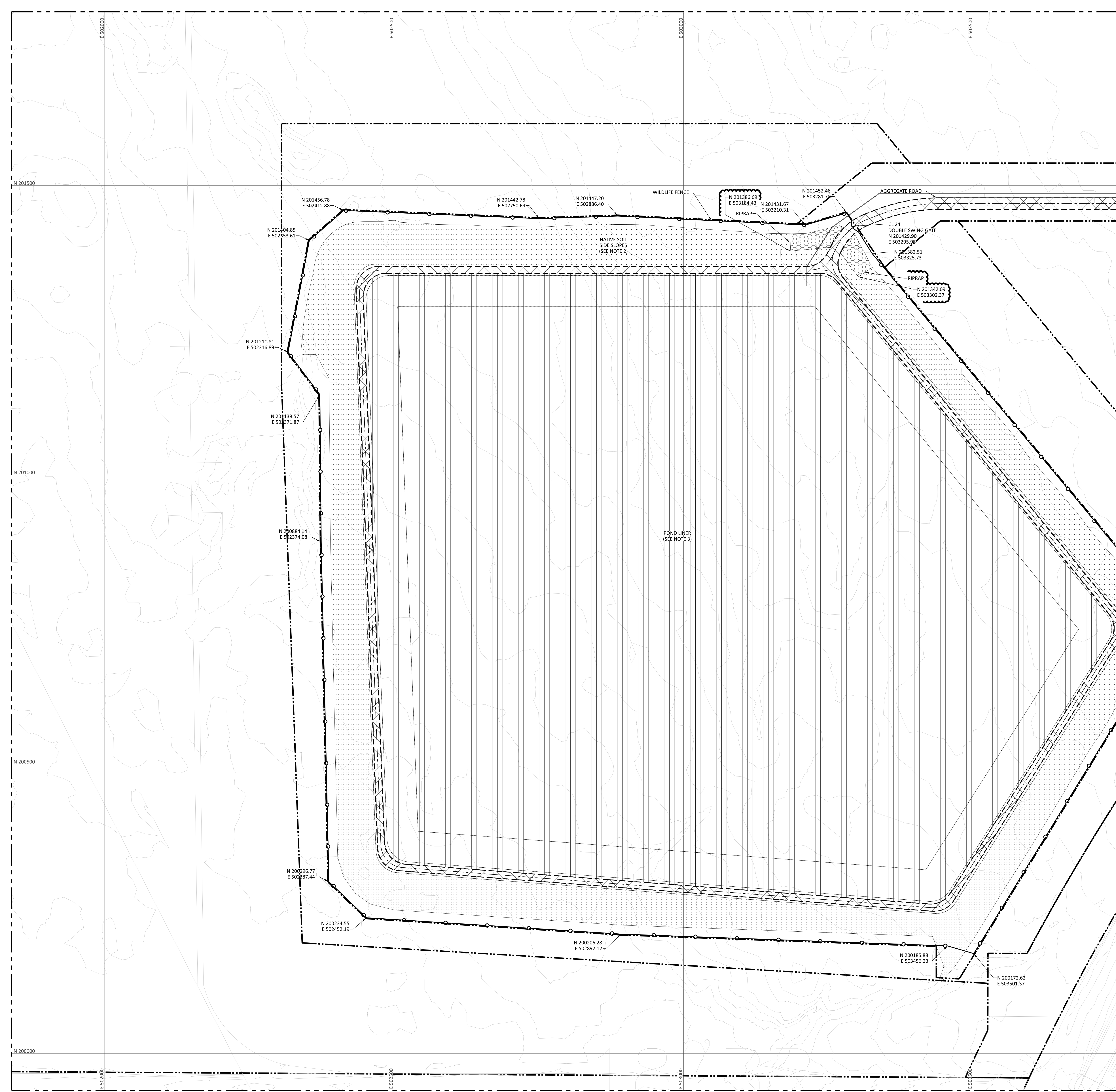

MATCHLINE - FOR CONTINUATION SEE S3202

MATCHLINE - FOR CONTINUATION SEE S3201

ALL BACKCIRCLES PER ECN N-S-0044

KEY PLAN

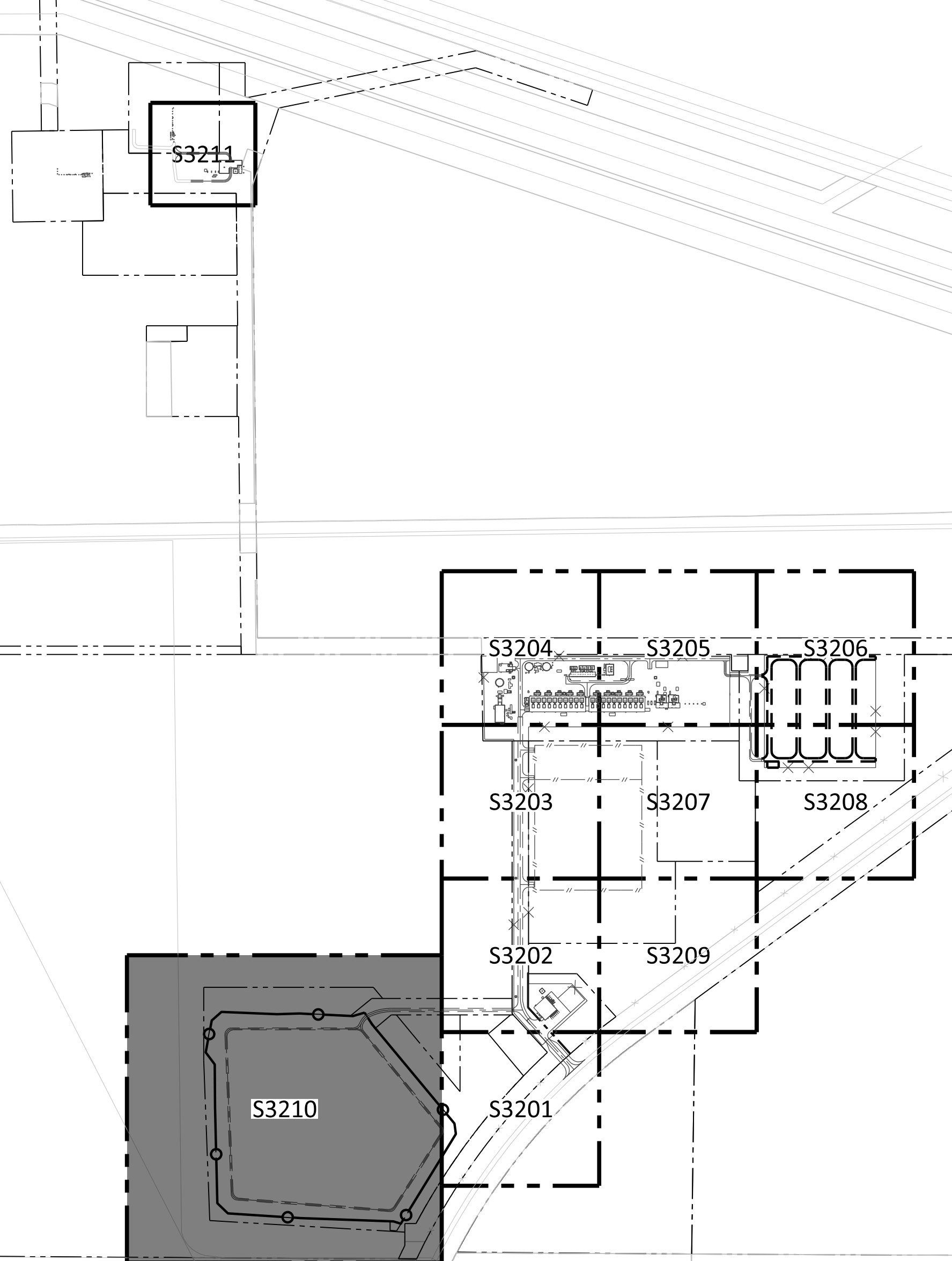

APPROVED FOR CONSTRUCTION

THE DISTRIBUTION AND USE OF THE NATIVE FORMAT CAD FILE OF THIS DRAWING IS UNCONTROLLED. THE USER SHALL VERIFY TRACEABILITY OF THIS DRAWING TO THE LATEST CONTROLLED VERSION.

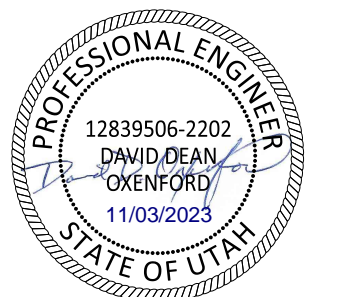

ADVANCED CLEAN ENERGY STORAGE I, LLC		PROJECT	DRAWING NUMBER	REV
ACES PROJECT I		411943-10STD-S3210		2
FENCING & SURFACING - SITE PLAN - AREA 10		CODE		
		AREA		

11/08/2023 11:45 AM
11/08/2023 11:45 AM
11/08/2023 11:45 AM

NO	DATE	REVISIONS AND RECORD OF ISSUE	DRN	DES	CHK	PDE	APP
2	03/NOV/23	REVISED PER ECN N-S-0044					
1	18/AUG/23	REVISED PER ECN N-S-0038					
0	07/JUL/23	ISSUED FOR CONSTRUCTION					

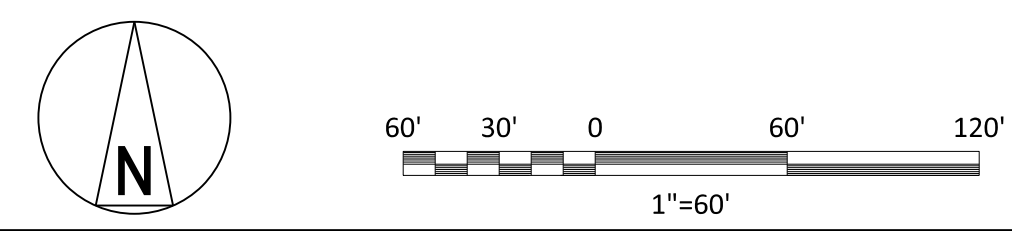

I HEREBY CERTIFY THAT THIS DOCUMENT WAS PREPARED BY ME OR UNDER MY DIRECT SUPERVISION AND THAT I AM A DULY REGISTERED PROFESSIONAL ENGINEER UNDER THE LAWS OF THE STATE OF UTAH.

SIGNED: DAVID DEAN OKENFORD
DATE: 07/JUL/23 REG NO: 12839506-2202

BLACK & VEATCH

DESIGNER: CAJ DRAWN: MTS
CHECKED: AMM DATE: 07/JUL/23

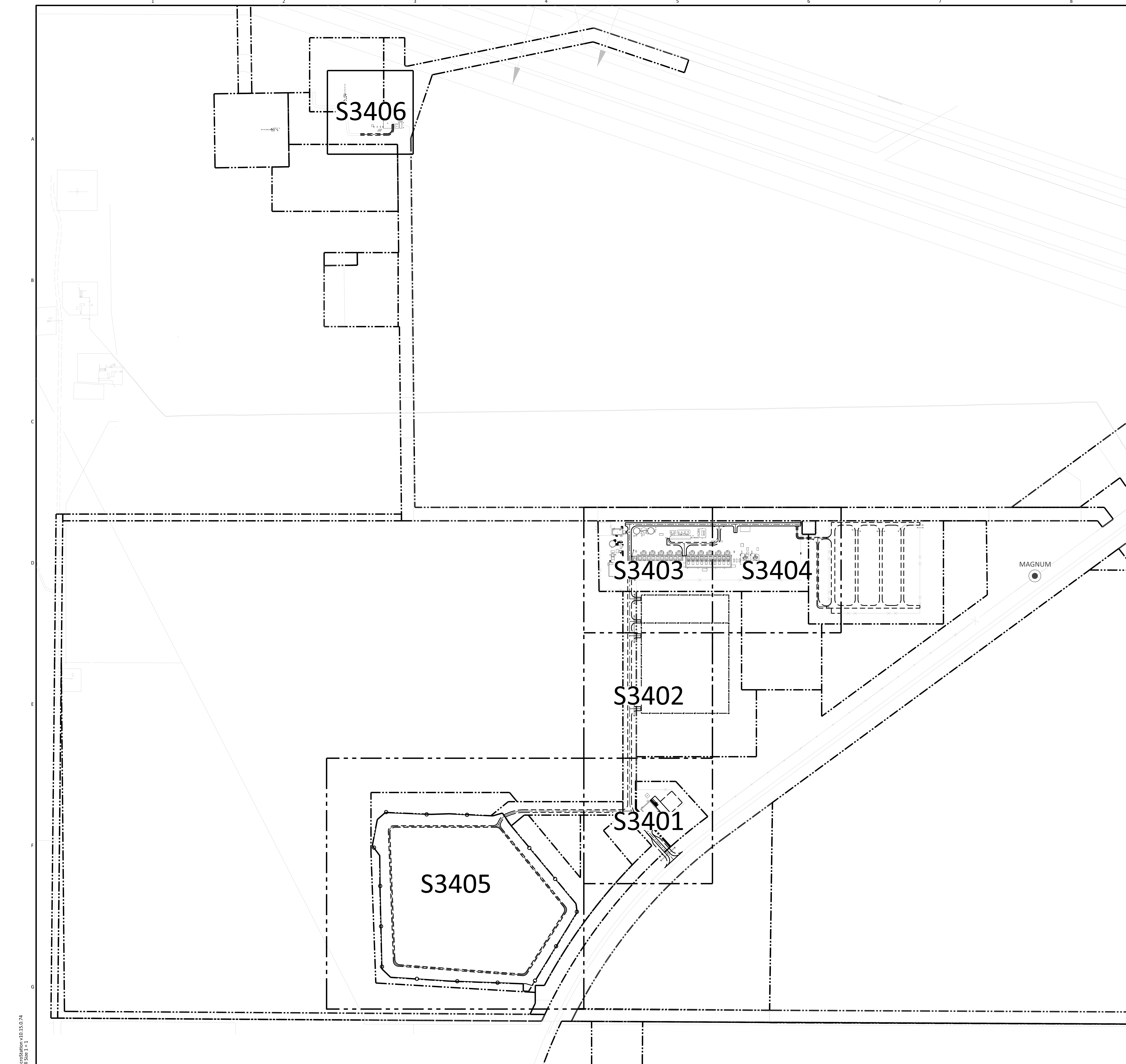

GENERAL NOTES
APPLICABLE TO ALL S3400 SERIES DRAWINGS

1. A SMOOTH VERTICAL TRANSITION SHALL BE PROVIDED AT ALL ROAD INTERSECTIONS AND VERTICAL POINTS OF INTERSECTION (VPI). VERTICAL CURVE LENGTHS SHALL BE AS SPECIFIED ON THE PLAN DRAWINGS AND SHALL BE 25-FOOT MINIMUM WHERE NOT NOTED.
2. NEW ROADS SHALL TIE INTO EXISTING ROADS AND EXISTING ROAD ELEVATIONS SHALL BE CONFIRMED. A SMOOTH VERTICAL TRANSITION SHALL BE MADE BETWEEN NEW AND EXISTING ROADS.
3. GENERAL PARKING SPACES SHALL BE 20 FT X 10 FT UNLESS NOTED OTHERWISE.
4. HANDICAP PARKING SPACES SHALL BE 20 FT X 11 FT UNLESS NOTED OTHERWISE. HANDICAP PARKING AISLES SHALL BE 20 FT X 9 FT UNLESS NOTED OTHERWISE. ALL HANDICAP PARKING SPACES SHALL INCLUDE A HANDICAP SIGN.
5. ALL AMERICANS WITH DISABILITIES ACT (ADA) REQUIREMENTS SHALL BE COMPLIED WITH, WHETHER SPECIFIED OR NOT SPECIFIED ON THE DRAWINGS. IF THERE IS A CONFLICT BETWEEN THE DRAWINGS AND THE ADA REQUIREMENTS, THE ADA REQUIREMENTS SHALL SUPERSEDE.
6. WHEEL STOPS SHALL BE INSTALLED WHERE INDICATED ON THE DRAWINGS, PER THE TYPICAL DETAIL ON DRAWING S3910. WHEEL STOPS SHALL BE CENTERED IN THE PARKING SPACE AND LOCATED THREE FEET FROM THE FRONT EDGE. WHEEL STOPS SHALL BE SECURELY INSTALLED TO THE GROUND. IF INSTALLED ON CONCRETE OR GRAVEL SURFACING, WHEEL STOPS SHALL BE PAINTED TO PROVIDE A CONTRASTING COLOR TO THE GROUND SURFACE COLOR.
7. ALL PARKING SPACES SHALL BE MARKED WITH PAINT STRIPING A MINIMUM OF 2 INCHES IN WIDTH. ALL HANDICAP SPACES AND AISLES SHALL BE MARKED WITH PAINT STRIPING A MINIMUM OF 2 INCHES IN WIDTH.

LEGEND
APPLICABLE TO ALL S3400 SERIES DRAWINGS

- PROPERTY BOUNDARY
- ==== ASPHALT ROAD
- GRAVEL ROAD
- x-x- SECURITY FENCE
- x-x-x- SUBSTATION FENCE
- /- FENCE BY OTHERS

**EXTENSIVE REVISIONS
PER ECN N-S-0044**

**APPROVED FOR
CONSTRUCTION**

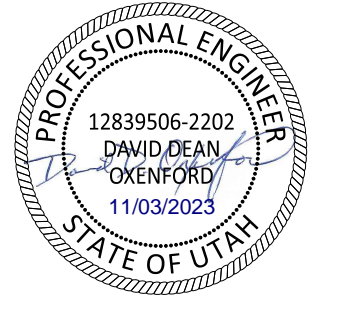

THE DISTRIBUTION AND USE OF THE NATIVE FORMAT CAD FILE OF THIS DRAWING IS UNCONTROLLED. THE USER SHALL VERIFY TRACEABILITY OF THIS DRAWING TO THE LATEST CONTROLLED VERSION.

S:\161606 - 107/27/2023 04:18 PM
 M:\CS\arson\1072723\1072723.dwg
 10/27/2023 04:18 PM

NO	DATE	REVISIONS AND RECORD OF ISSUE	DRN	DES	CHK	PDE	APP
1	03/NOV/23	REVISED PER ECN N-S-0044	MTS	MTS	CAF	DDO	CG
0	06/SEP/22	ISSUED FOR CONSTRUCTION	MTS	CAF	FA	DDO	CG

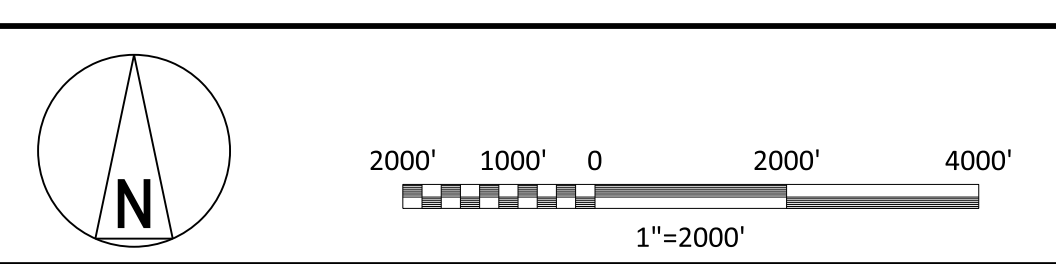

I HEREBY CERTIFY THAT THIS DOCUMENT WAS PREPARED BY ME OR UNDER MY DIRECT SUPERVISION AND THAT I AM A DULY REGISTERED PROFESSIONAL ENGINEER UNDER THE LAWS OF THE STATE OF UTAH

SIGNED: DAVID DEAN OKENFORD
 DATE: 06/SEP/22 REG. NO.: 12839506-2202

BLACK & VEATCH

DESIGNER: CAF	DRAWN: MTS
CHECKED: FA	DATE: 06/SEP/22

ADVANCED CLEAN ENERGY STORAGE I, LLC ACES PROJECT I ROADS & PARKING - SITE KEY PLAN, GENERAL NOTES & LEGEND		PROJECT: 411943-10STA-S3400 DRAWING NUMBER: 1 REV: 1
---	--	--

- 1. SEE DRAWING S3400 FOR GENERAL NOTES AND LEGEND.
- 2. THE NORTH ROAD EDGE SHALL BE SET AT OR BELOW EXISTING GRADE TO ENSURE OFFSITE DRAINAGE FROM THE NORTH IS NOT BLOCKED.

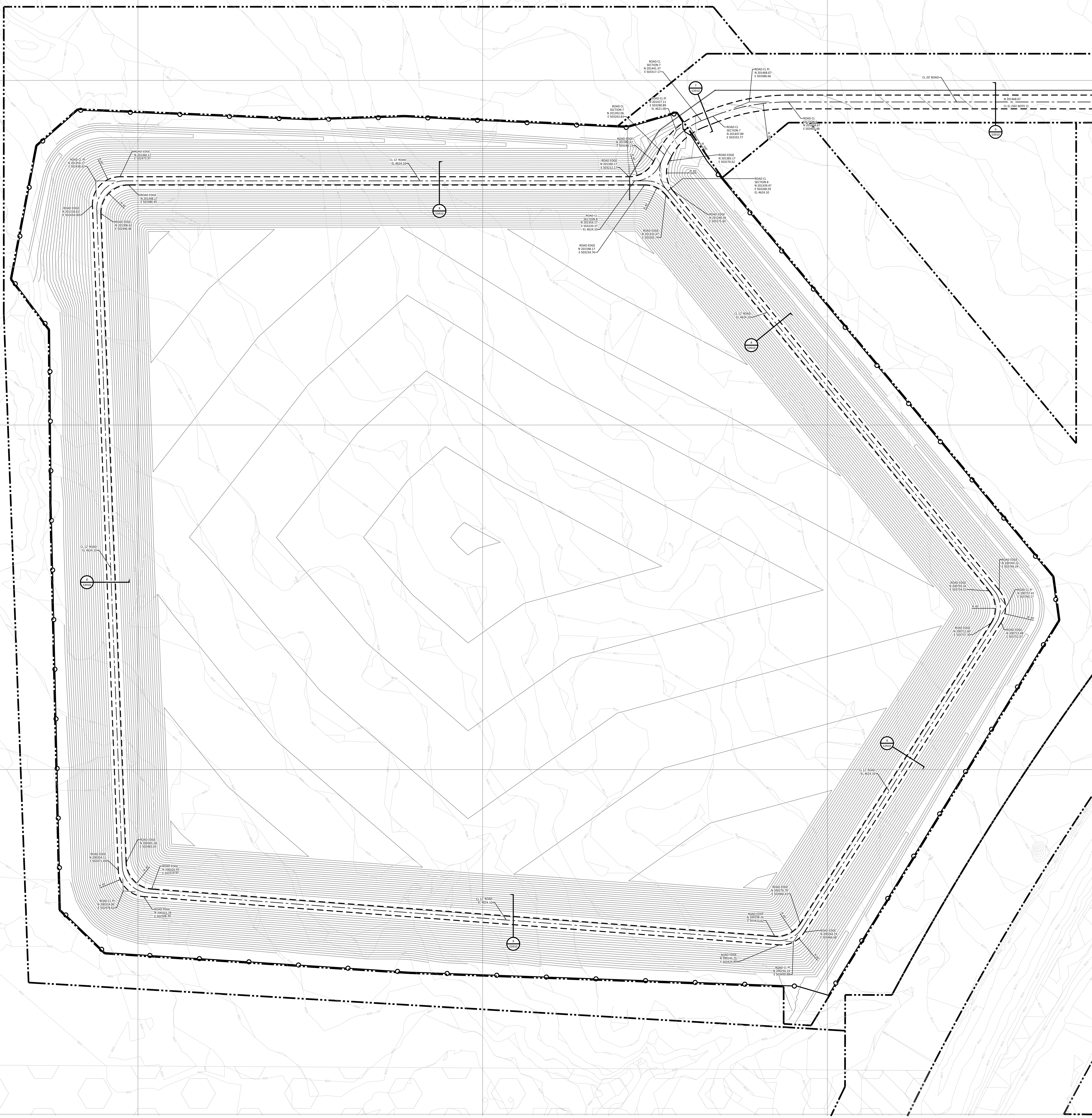

MATCHLINE - FOR CONTINUATION SEE S3401

**EXTENSIVE REVISIONS
PER ECN N-S-0044**

KEY PLAN

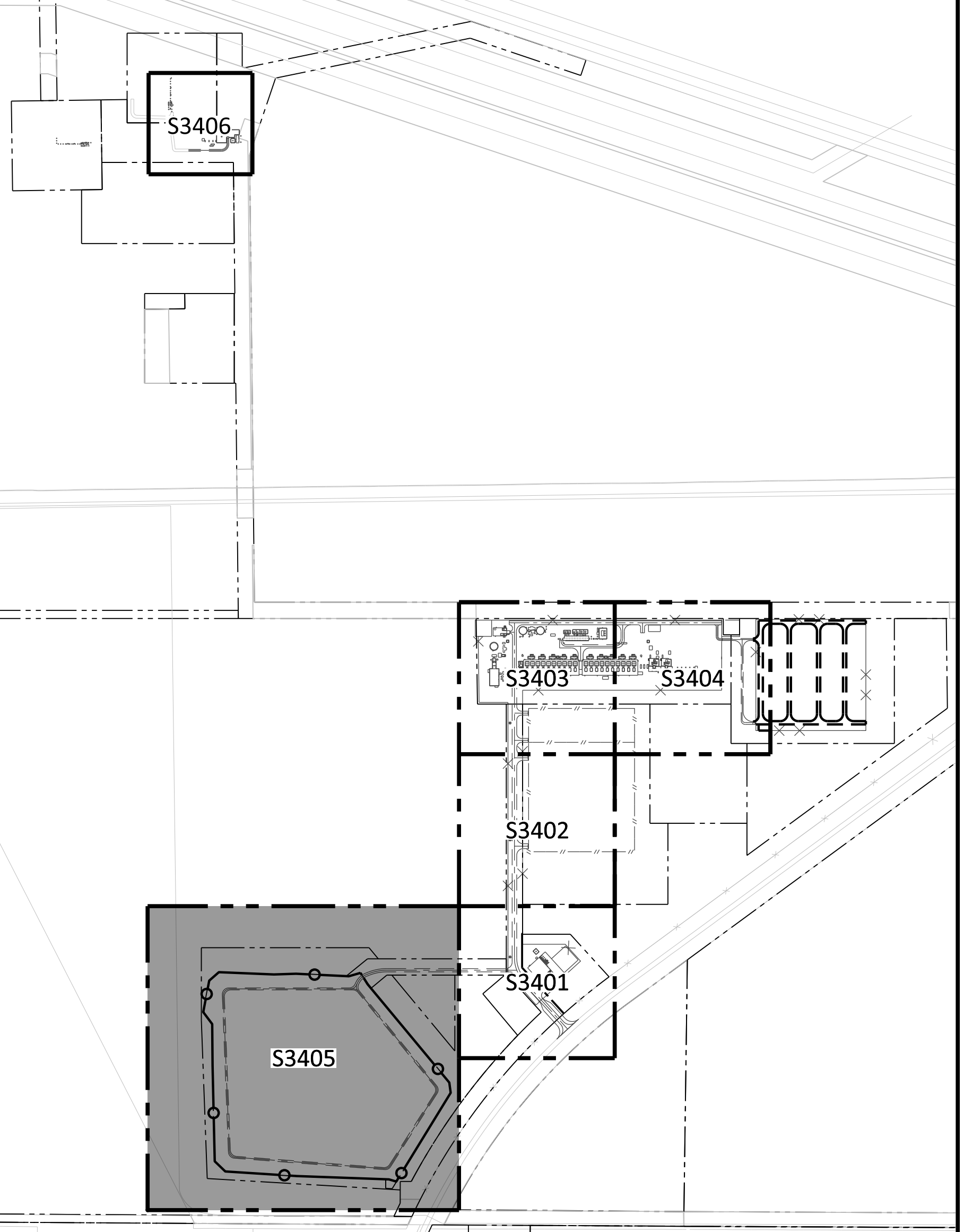

**APPROVED FOR
CONSTRUCTION**

THE DISTRIBUTION AND USE OF THE NATIVE FORMAT CAD FILE OF THIS DRAWING IS UNCONTROLLED. THE USER SHALL VERIFY TRACEABILITY OF THIS DRAWING TO THE LATEST CONTROLLED VERSION.

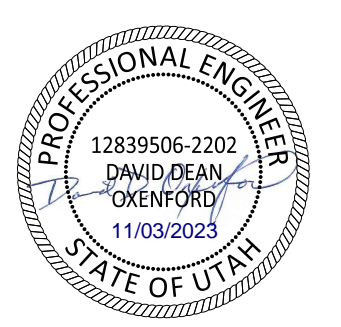

ADVANCED CLEAN ENERGY STORAGE I, LLC		PROJECT	DRAWING NUMBER	REV
ACES PROJECT I		411943-10STA-S3405		1
ROADS & PARKING - SITE PLAN - AREA 5		CODE		
		AREA		

BLACK & VEATCH	
DESIGNER	DRAWN
MTS	MTS
CAP	DATE
AMM	07/05/23

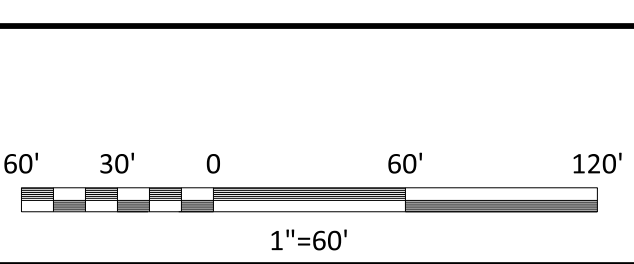

NO	DATE	REVISIONS AND RECORD OF ISSUE	DRN	DES	CHK	PDE	APP
1	03/NOV/23	REVISED PER ECN N-S-0044	MTS	MTS	CAF	DDO	CG
0	07/JUL/23	ISSUED FOR CONSTRUCTION	MTS	CAF	AMM	DDO	CG

10/08/23
10/23/2023 04:20 PM

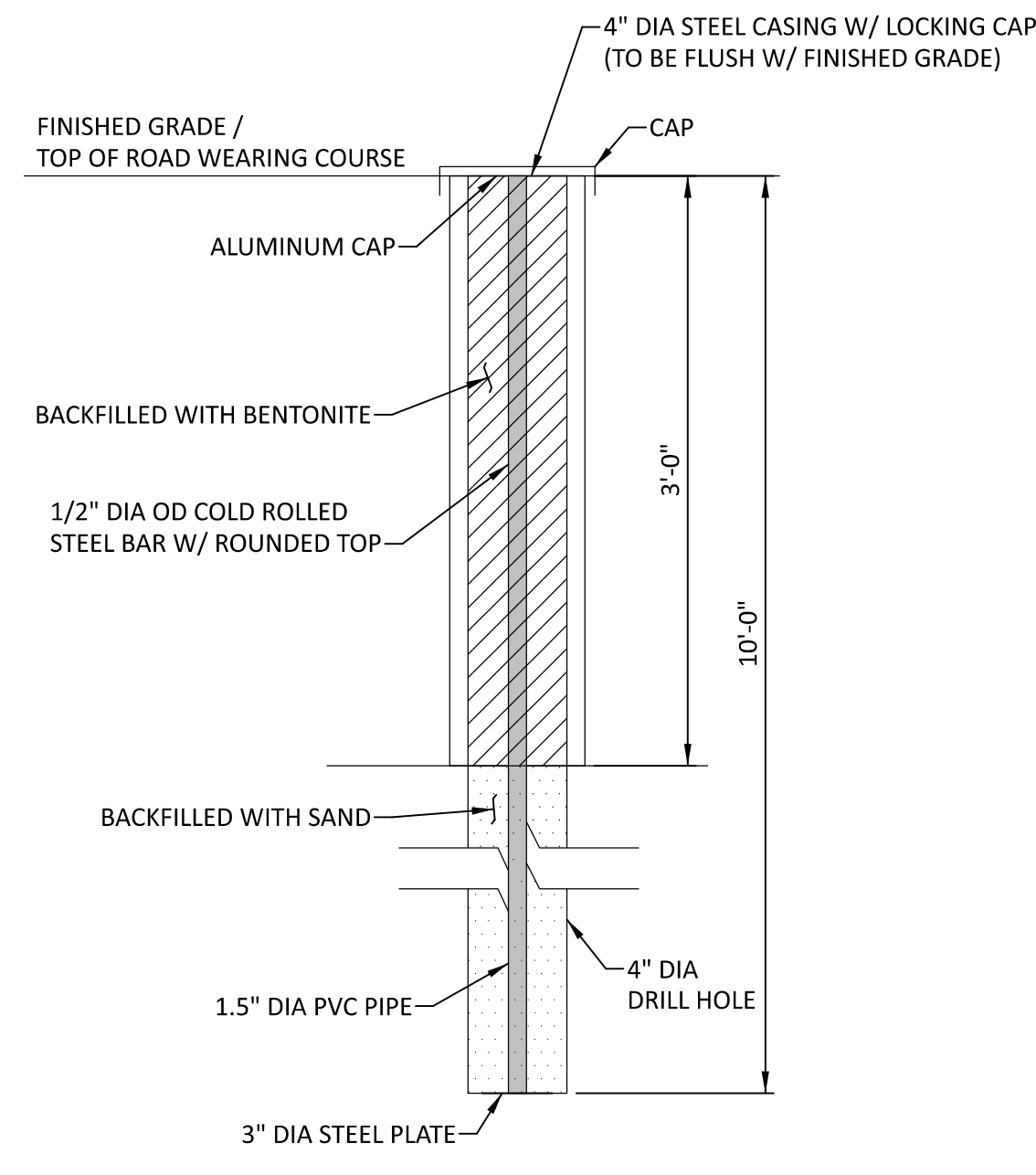

TYPICAL SETTLEMENT MONUMENT
SEE DRAWING 411943-10STF-S3011B
NO SCALE

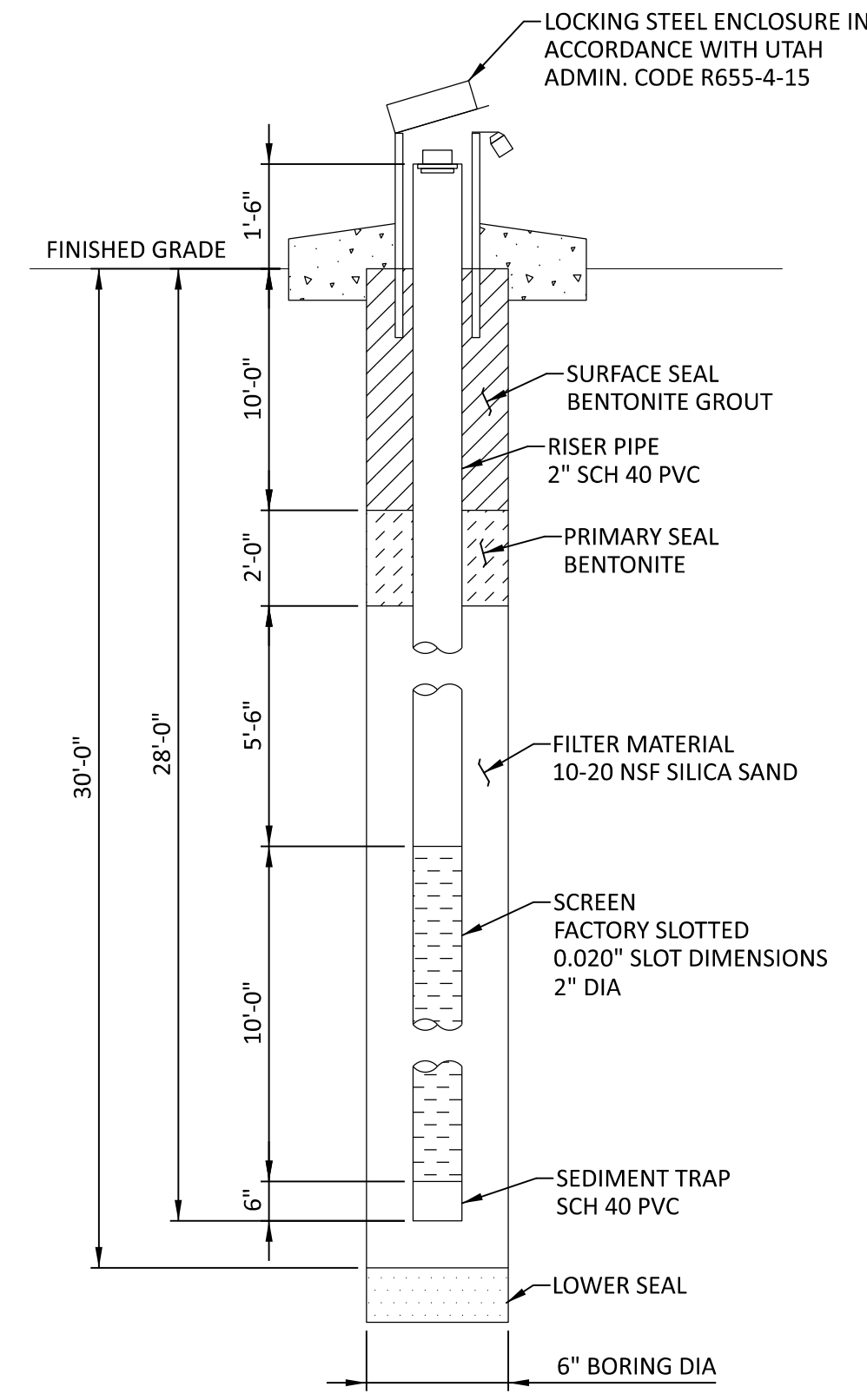

TYPICAL MONITORING WELL
SEE DRAWING 411943-10STF-S3011B
NO SCALE

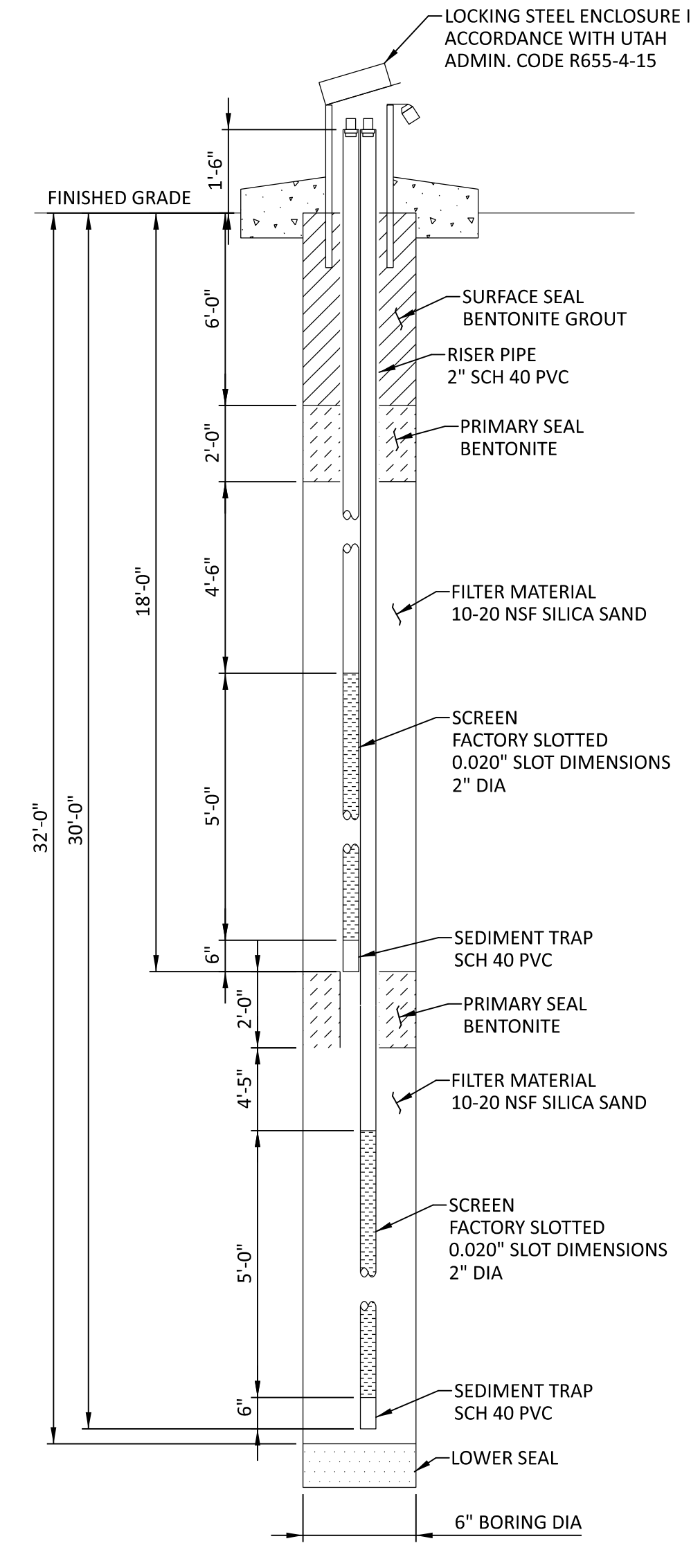

TYPICAL PIEZOMETER
SEE DRAWING 411943-10STF-S3011B
NO SCALE

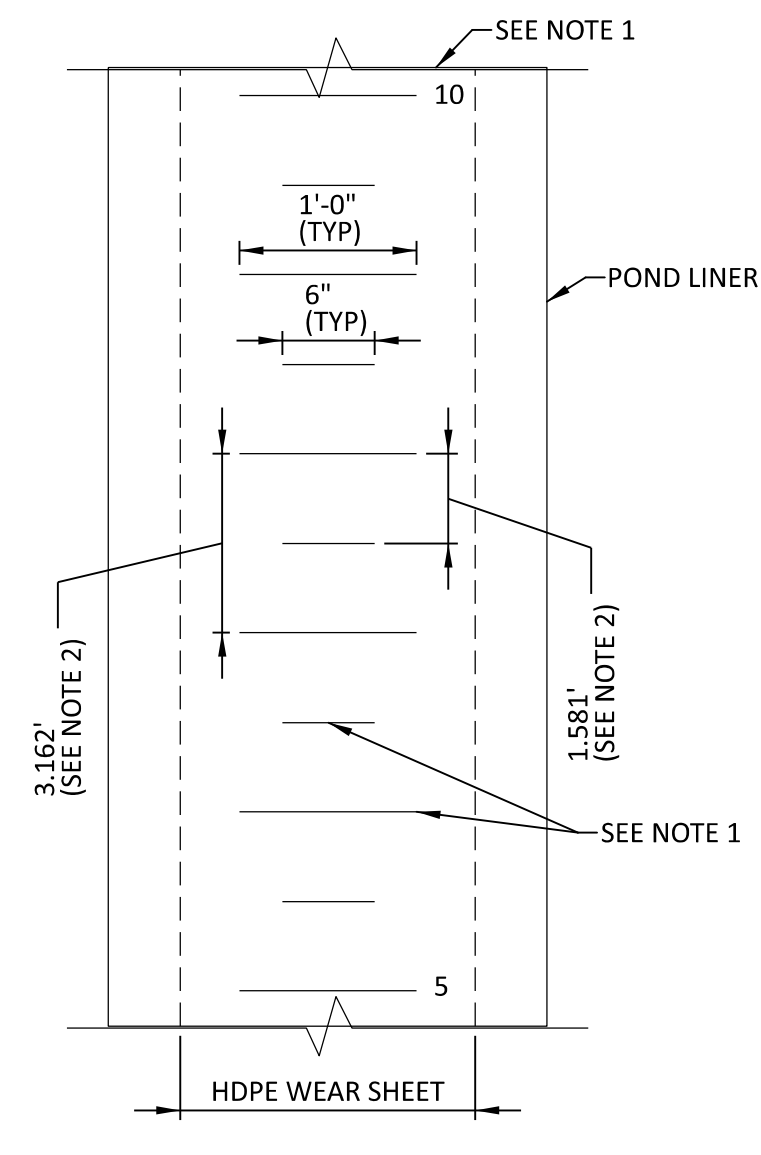

TYPICAL WATER LEVEL GAUGE
SEE DRAWING 411943-10STF-S3011B
NO SCALE

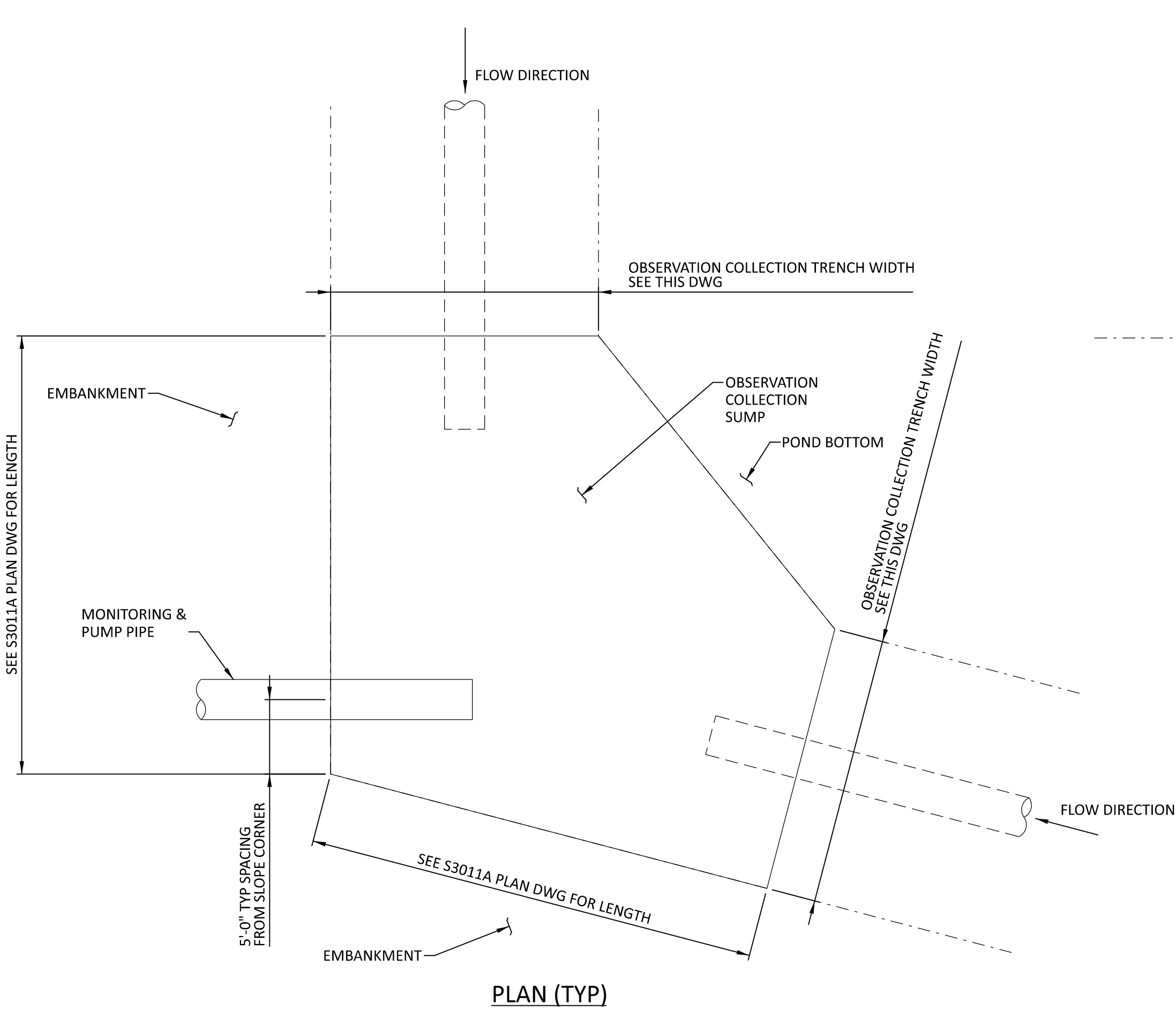

PLAN (TYP)

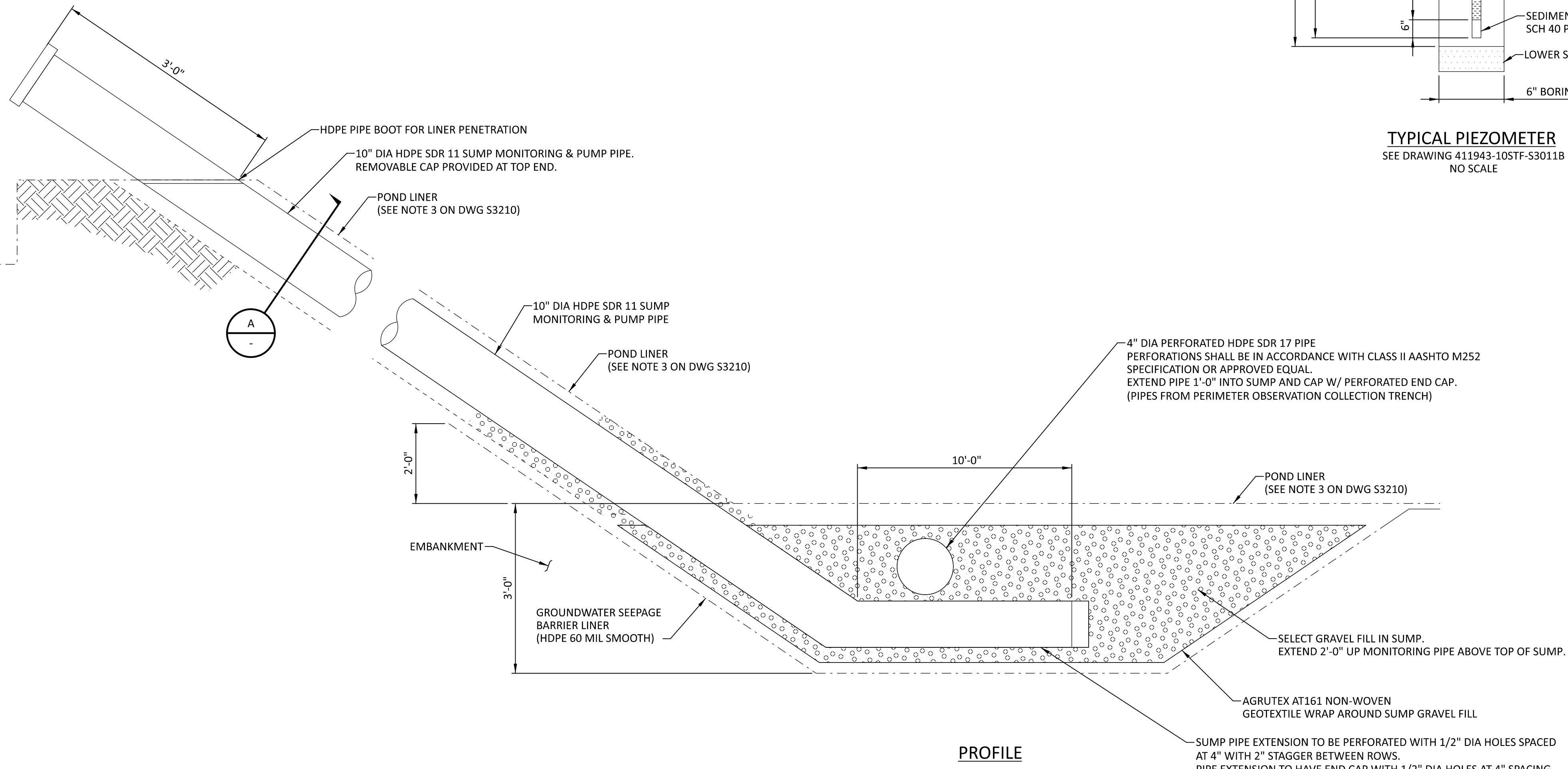

PROFILE

OBSERVATION COLLECTION SUMP
SEE DRAWING 411943-10STF-S3011A
(SHW 4 PLACES)
NO SCALE

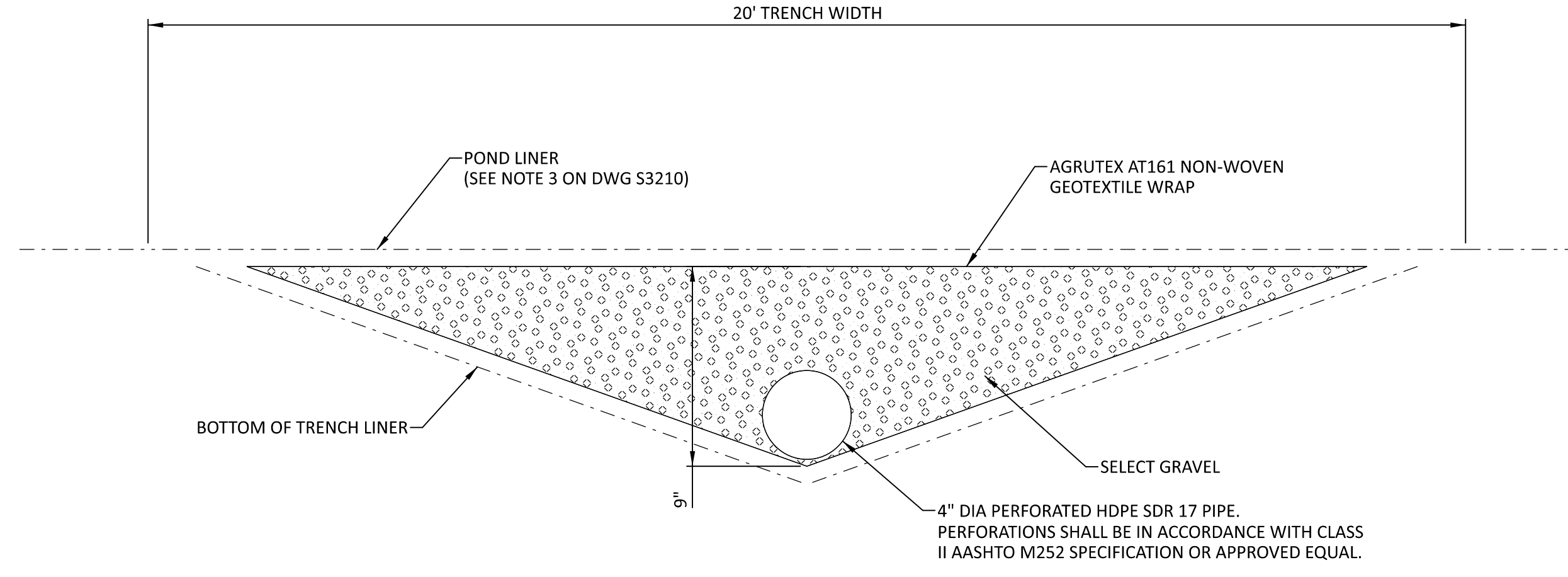

OBSERVATION COLLECTION TRENCH
SEE DRAWING 411943-10STF-S3011A
NO SCALE

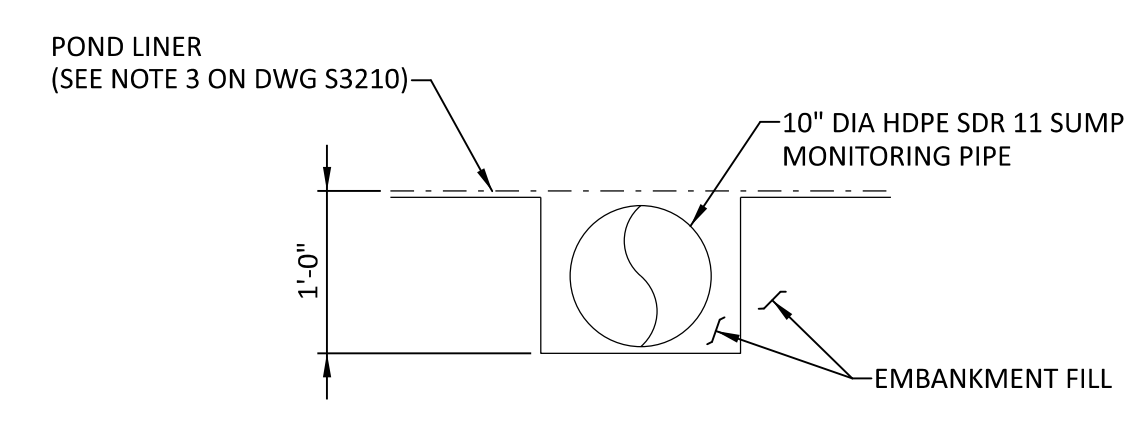

SECTION A
THIS DRAWING
NO SCALE

- NOTES:**
- PIPE TO BE LOCATED IN TRENCH, BELOW PLANE OF EMBANKMENT, BACKFILLED WITH EMBANKMENT FILL MATERIAL.
 - PIPE SHALL BE INSTALLED STRAIGHT TO FACILITATE SUMP MONITORING AND PUMP/OUT.

**EXTENSIVE REVISIONS
PER ECN N-S-0044**

- NOTES**
- WATER LEVEL GAUGE NOTES:**
- EXTRUDE INCREMENTS ONTO HDPE WEARSHEET AND APPLY FLUORESCENT COLOR PAINT TO ALL INCREMENTS AND LABEL EVERY 5 FEET.
 - SLOPE DISTANCES SHOWN CORRELATE TO VERTICAL INCREMENTS OF 6" AND 1" ON A 3:1 (H:V) SIDE SLOPE (TO BE FIELD VERIFIED BY SURVEY).
- MONITORING WELL & PIEZOMETER NOTES:**
- MONITORING WELLS SHALL BE CONSTRUCTED IN COMPLIANCE WITH UTAH ADMINISTRATIVE RULE 8655-4-15. PIEZOMETER SHALL BE IN ACCORDANCE WITH 8655-4 AS WELL.
 - ESTIMATED DEPTH TO WATER IS APPROXIMATELY 15 TO 20 FEET BELOW EXISTING GROUND SURFACE.
 - HOLLOW STEM AUGER DRILLING METHOD IS PREFERRED. OTHER METHODS CAN BE CONSIDERED BASED ON RIG AVAILABILITY AND APPROVAL FROM THE ENGINEER.
 - FILTER PACK AND WELL SEALANTS SHALL BE TREMIED IN PLACE FROM THE BOTTOM UP.
 - WELLS SHALL BE DEVELOPED BY BAILING, SURGING, OR PUMPING WATER FROM THE WELLS UNTIL FIVE CASING VOLUMES OF WATER HAVE BEEN REMOVED FROM THE WELL AND THE DISCHARGE WATER IS CLEAR, AND SOUNDINGS INDICATE ALL LOOSE MATERIAL HAS BEEN REMOVED FROM THE BOTTOM OF THE WELL. THE WELLS SHALL NOT BE DEVELOPED BY REMOVING THE WATER FROM THE WELL USING COMPRESSED AIR JETS DIRECTED AT THE SCREEN. SURGING BY AIRLIFT IS ACCEPTABLE.

**APPROVED FOR
CONSTRUCTION**

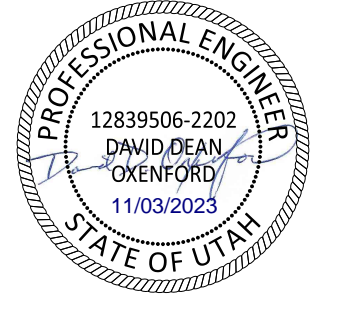

BLACK & VEATCH		ADVANCED CLEAN ENERGY STORAGE I, LLC	PROJECT 411943-10STF-S3911A	DRAWING NUMBER 2
DESIGNER CAF	DRAWN CAF	SITE - CIVIL TYPICAL DETAILS - EVAPORATION POND		REV 2
CHECKED AMM	DATE 07/18/23	AREA		

I HEREBY CERTIFY THAT THIS DOCUMENT WAS PREPARED BY ME OR UNDER MY DIRECT SUPERVISION AND THAT I AM A DULY REGISTERED PROFESSIONAL ENGINEER UNDER THE LAWS OF THE STATE OF UTAH.		REG. NO. 12839506-2202
SIGNED DAVID DEAN OXFENFORD	DATE 07/18/23	CHECKED AMM

NO.	DATE	REVISIONS AND RECORD OF ISSUE	DRN	DES	CHK	PDE	APP
2	03/NOV/23	REVISED PER ECN N-S-0044	MTS	MTS	CAF	DDO	CG
1	18/AUG/23	REVISED PER ECN N-S-0038	MTS	GDV	CAF	DDO	CG
0	07/JUL/23	ISSUED FOR CONSTRUCTION	CAF	CAF	AMM	DDO	CG
NO		REVISIONS AND RECORD OF ISSUE	DRN	DES	CHK	PDE	APP

11/02/2023 11:45 AM
11/02/2023 11:45 AM
11/02/2023 11:45 AM

Schedule A Materials, Compaction, and Testing Requirements										
Material	Plasticity Requirements	Gradation Requirements	Maximum Dry Density	Maximum Density Test Frequency	Required Field Density	Field Density Test	Field Density Test Frequency	Required Field Water Content	Field Water Content Test	Required Lift Thickness
Subgrade	All subgrades shall be cleared, scarified, level, and proof rolled with witnessing and approval by a qualified soil technician and construction management required prior to fill placement, unless further directed in table below. Subgrade surface shall be scarified to ensure the subgrade surface will be well bonded to the layers of fill. Areas identified as soft or excessively disturbed shall be removed and replaced with compacted soil for the type of fill that will be placed upon the subgrade. Subgrades shall be sealed with a smooth drum roller when inclement weather is expected, then scarify prior to adding overlying lifts. Standing water is not permitted. Allow areas that have been exposed to heavy rain or standing water to dry to within 2 percent of optimum water content prior to adding overlying lifts. Stabilize subgrades that are otherwise solid, but mucky on top due to construction operations, by reinforcing them with one or more layers of crushed rock or gravel unless otherwise noted on the drawings.									
Embankment Subgrade	-	-	ASTM D698, Method C	1 initial test; further tests as directed	95% Max. Dry Density	ASTM D6938; ASTM D1556	One test per 50,000 sf or as required.	-2% to +2% of optimum water content	ASTM D6938; ASTM D1556	6 inches (200 mm) depth
Embankment Fill	LL < 40 PI < 15 One test per 10,000 cy, or as required	6 inch (150 mm) max; 3 inch (75 mm) max in upper 18 inches (460 mm) One test per 10,000 cy, or as required	ASTM D698, Method C	3 initial tests, further tests as directed, with minimum 1 per 10 field tests	95% Max. Dry Density	ASTM D6938; ASTM D1556	One test per 2000 cy, min 1" per lift per day, or as required	-2% to +2% of optimum water content	ASTM D6938; ASTM D1556	8 inches (200 mm) thick lift prior to compaction (loose lift)
Liner Subgrade	-	The six inches of soil immediately beneath the liner shall be inorganic, free of all rocks, stones, sticks, and debris of any kind, with no particle larger than three-eighths inch diameter. Angular, sharp material is not allowed in the subgrade, regardless of diameter	ASTM D698, Method C	1 initial test; further tests as directed	95% Max. Dry Density	ASTM D6938; ASTM D1556	One test per 100,000 sf, or as required.	-2% to +2% of optimum water content	ASTM D6938; ASTM D1556	6 inches (200 mm) depth
Select Gravel	Non-plastic	100% passing 2" 70-30% passing 1.5" 15-0% passing 1" 5-0% passing 0.5"	ASTM D4253 and D4254	3 initial tests; further tests as directed	70% Relative Density	ASTM D2922; ASTM D1556 or ASTM D2167	One test per 200 cy, or as required	Surface Moist	-	8 in. uncompacted

Evaporation Pond Filling Curve

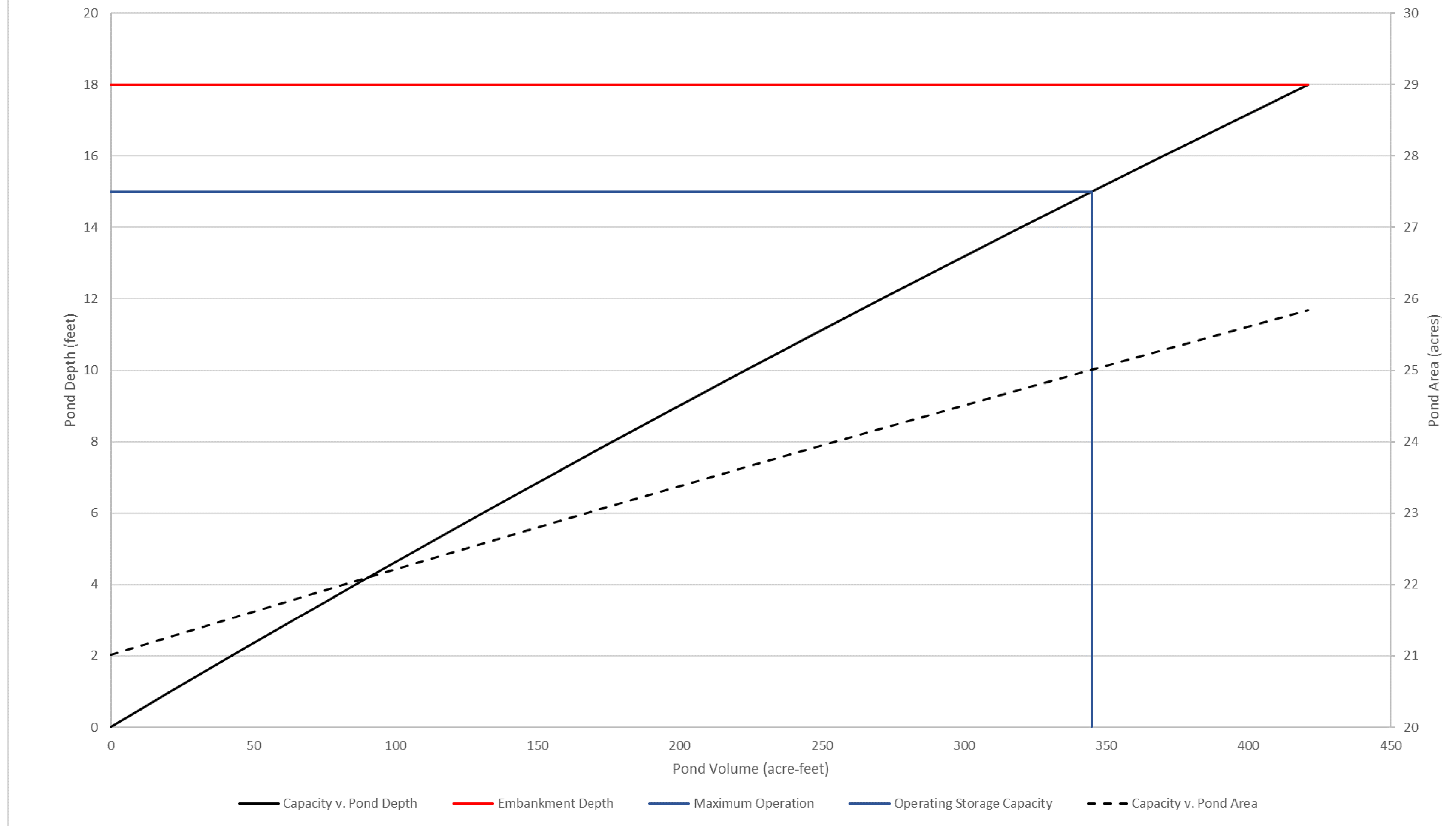

NOTES

APPROVED FOR CONSTRUCTION
 THE DISTRIBUTION AND USE OF THE NATIVE FORMAT CAD FILE OF THIS DRAWING IS UNCONTROLLED. THE USER SHALL VERIFY TRACEABILITY OF THIS DRAWING TO THE LATEST CONTROLLED VERSION.

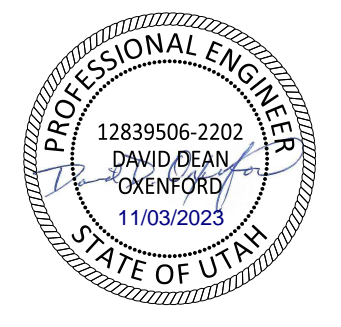

PROJECT	ADVANCED CLEAN ENERGY STORAGE I, LLC	DRAWING NUMBER	411943-10STF-S3911B	REV	0
SITE - CIVIL		CODE			
TYPICAL DETAILS - EVAPORATION POND		AREA			

DESIGNER	MTS	DRAWN	MTS
CHECKED	CAF	DATE	03/NOV/23

NO	DATE	ISSUED FOR CONSTRUCTION	MTS	MTS	CAF	DDO	CJG
0	03/NOV/23	ISSUED FOR CONSTRUCTION	MTS	MTS	CAF	DDO	CJG

11/02/2023 11:42 AM
 11/02/2023 11:42 AM
 11/02/2023 11:42 AM

APPENDIX B

**GROUNDWATER MONITORING PLAN
ADVANCED CLEAN ENERGY STORAGE I, LLC:
COOLING AND BLOWDOWN WATER POND**

Groundwater Monitoring Plan

Draft

February 4, 2021

Prepared by

NewFields

9400 Station Street, Suite 300

Lone Tree, CO 80124

Tel 720 508 3300 Fax 720 508 3339

www.newfields.com

Table of Contents

Section 1	Introduction	1-1
	1.1 Plan Purpose	1-1
	1.2 Local Hydrogeology	1-1
	1.3 Storage Cavern Field Groundwater Monitoring	1-3
	1.4 Brine Evaporation Pond Groundwater Monitoring.....	1-4
Section 2	Groundwater Monitoring Methods	2-1
	2.1 Storage Cavern Field Groundwater Level Monitoring Methods	2-1
	2.2 Storage Cavern Field Groundwater Quality Monitoring Methods	2-2
	2.3 Brine Evaporation Ponds Groundwater Quality Monitoring Methods	2-3
	2.3.1 Exceedances.....	2-4
Section 3	Agency Reporting and Notification.....	3-1
	3.1 Storage Cavern Field Groundwater Level Reporting and Notification	3-1
	3.2 Storage Cavern Field Groundwater Quality Reporting and Notification.....	3-1
	3.3 Brine Evaporation Pond Groundwater Quality Reporting and Notification.....	3-1
	3.4 Brine Evaporation Pond Leak Detection System Reporting, Notification, and Corrective Action.....	3-3
Section 4	Record Retention.....	4-1
	4.1 Records	4-1

Tables

Table 1: Summary of Local Hydrology	1-2
Table 2: Storage Cavern Field Groundwater Level Monitoring Schedule	2-2
Table 3: Storage Cavern Field Groundwater Quality Monitoring Schedule	2-3
Table 4: DWQ Interim Groundwater Protection Levels.....	2-4
Table 5: Brine Evaporation Pond Groundwater Quality Monitoring Schedule.....	2-4
Table 6: Brine Evaporation Pond Maximum Allowable Leakage Rates	3-4

Figures

Figure 1 Hydrostratigraphy of the Project Area	1-3
Figure 2 Aquifer Monitoring Well Network.....	1-5

Appendices

Appendix A. Groundwater Sampling Quality Assurance Procedures
Appendix B. Monitoring Forms

This page left intentionally blank.

Section 1

Introduction

1.1 Plan Purpose

This Groundwater Monitoring Plan has been developed to describe the processes and procedures for groundwater monitoring and agency reporting for the Magnum Solution Mining, LLC (Company) hydrogen production and storage facility. The facility is located approximately ten miles north of Delta in Millard County, Utah on lands leased from the School and Institutional Trust Lands Administration (SITLA). The storage facility consists of a Storage Cavern Field; a series of electrolyzer banks, an approximately 168-acre brine pond; a substation with an associated electric distribution and high voltage system; office and warehouse buildings; water production wells; and associated buried piping and utilities. The monitoring procedures in this Plan pertain only to the monitoring of potential effects to groundwater relative to the construction and operation of storage caverns within the Storage Cavern Field and the operation of the brine pond.

The Company has committed to groundwater monitoring within the confines of the facility using a network of existing and proposed groundwater production, observation and monitoring wells. Groundwater monitoring activities for the facility are under the jurisdiction of the Department of Environmental Quality, Division of Water Quality (DWQ). The Plan is written to comply with the requirements of all project permits.

1.2 Local Hydrogeology

Groundwater beneath the hydrogen storage facility occurs in unconsolidated sediments within the Sevier Desert Basin aquifer system. Four aquifers units are of interest (from shallowest to deepest):

- The water table aquifer;
- The shallow artesian aquifer;
- The deep artesian aquifer; and
- The basement aquifer.

Table 1 provides a summary of the four aquifers. Figure 1 is a graphical depiction of the aquifers' hydrostratigraphy. The aquifers depths have been refined utilizing a geologic model constructed based on drilling data from wells constructed by the Company.

There is currently a network of groundwater production, observation and monitoring wells for monitoring groundwater levels and groundwater quality within the aquifers depicted in Figure 1. The Company also has permission from the adjacent landowners to monitor groundwater levels in their respective water production wells. Figure 2 depicts the location of the network of groundwater wells that will be used for groundwater monitoring.

Table 1: Summary of Local Hydrology

Depth (feet bgs)	Aquifer Name	Aquifer Description and Use
0 to 250	Water table aquifer	The water table aquifer is unconfined and generally not used within the area due to high total dissolved solids and poor quality conditions. (The Sawtooth GA and the Company's B-P wells are currently used to monitor water quality)
300 to 600	Shallow artesian aquifer	Confining zones vary in thickness and location and can include several hundred feet of the identified depths. This aquifer is generally used for agricultural and drinking water purposes. (The Sawtooth DA wells and Egg Farm off-site well are currently used to monitor water levels)
700 to 1,400	Deep artesian aquifer	Confining zones vary in thickness and location and can include several hundred feet of the identified depths. This aquifer is generally used for industrial and drinking water purposes. This is the aquifer from which water will be produced for the facility. (The Sawtooth DA wells and the IPP off-site well are currently used to monitor water levels)
> 1,650 to 3,000	Basement aquifer	This aquifer extends to bedrock or the salt structure and includes several small inter-bedded sand and gravel units within significant silt and clay zones. (Sawtooth currently owns and operates the MH wells to monitor water levels and quality and DA wells to monitor water levels)

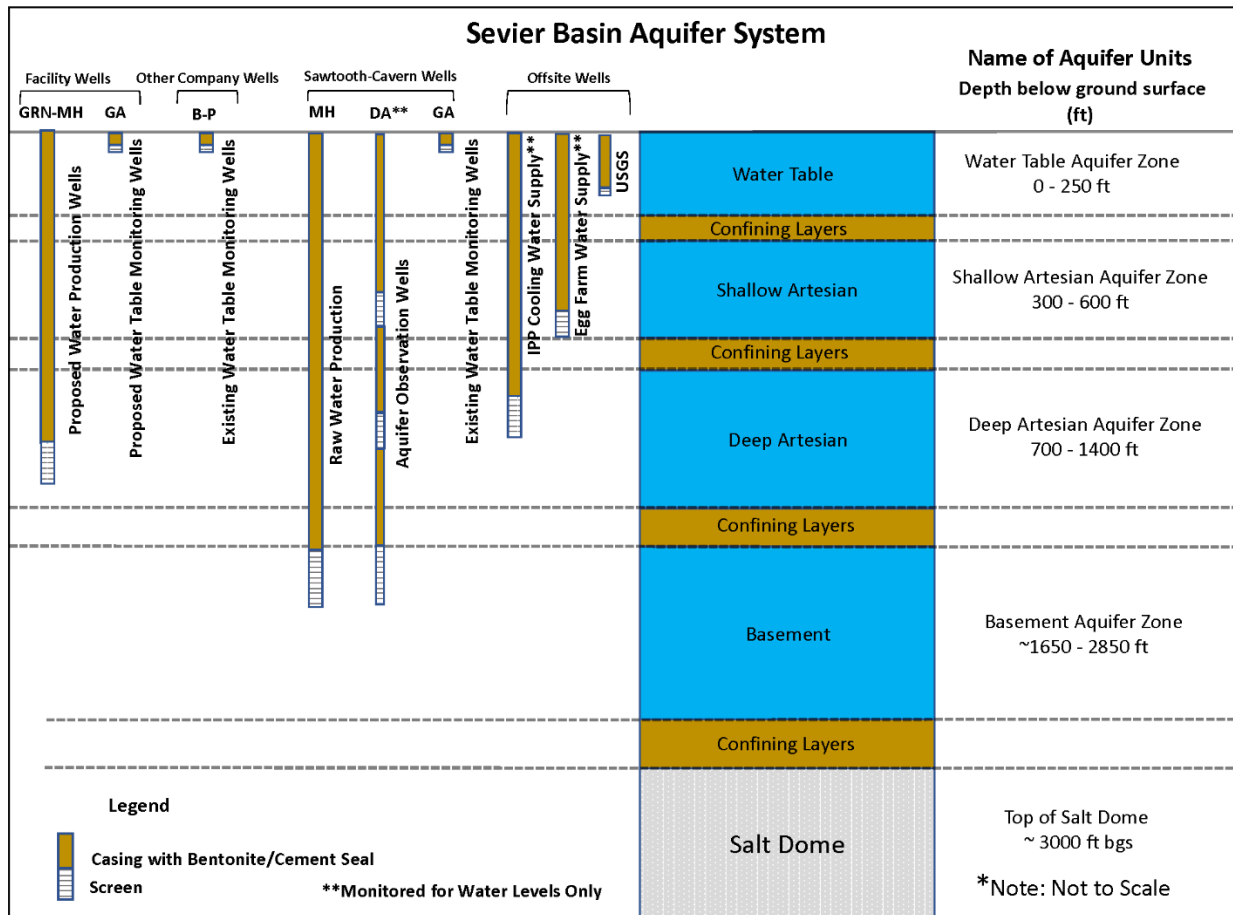

Figure 1 Hydrostratigraphy of the Project Area

1.3 Storage Cavern Field Groundwater Monitoring

Groundwater monitoring activities associated with the storage caverns will entail both groundwater level and groundwater quality monitoring. The storage caverns will be constructed in a salt formation that is located approximately 3,000 feet below the ground surface (bgs) using standard solution mining technology. Water for the solution mining process will be obtained through off-site water supply agreements and/or from three proposed water production wells (GRN-MH-1, GRN-MH-2, and GRN-MH-3; see Figure 2). Water chemistry testing indicates that water from the basement aquifer is not suitable for all facility components (e.g.: cooling towers), therefore the Company is proposing to produce groundwater for this facility from the deep artesian aquifer. While multiple hydrological analyses indicate that Company’s production from the deep artesian and basement aquifers will not drawdown the overlaying shallow artesian aquifers, the Company has committed to monitoring the shallow artesian, deep artesian, and basement aquifers to ensure groundwater levels are not negatively affected by solution mining activities (see Table 1 and Figure 1).

In addition to water level monitoring, the Company has also committed to monitoring groundwater quality in the deep artesian aquifer during solution mining and storage cavern operations.

1.4 Brine Evaporation Pond Groundwater Monitoring

Groundwater monitoring activities associated with the brine evaporation ponds will entail groundwater quality monitoring and leak detection system monitoring to protect the water table aquifer. The 168-acre pond will be constructed with a double geomembrane liner system with a leak detection system composed of a Leak Collection and Recovery System (LCRS) between the liners and a Process Component Monitoring System (PCMS) below the liners. The purpose of monitoring the leak detection system is to ensure that the system is working in accordance with the pond design, thereby reducing the potential for significant leaks through the bottom pond liner. In addition, groundwater monitoring wells around the perimeter and on the berms of the pond will be installed in the water table aquifer, as shown in Figure 2. The purpose of the monitoring wells is to monitor water level and for elevated conductivity, sodium, TDS, or chloride levels that could indicate a leak in the double liner system. In sum, the design provides for three levels of protection to ensure groundwater quality in the water table aquifer is not negatively affected by the brine pond: 1) the double geomembrane liner system; 2) the dual leak detection and collection system; and 3) the network of groundwater monitoring wells.

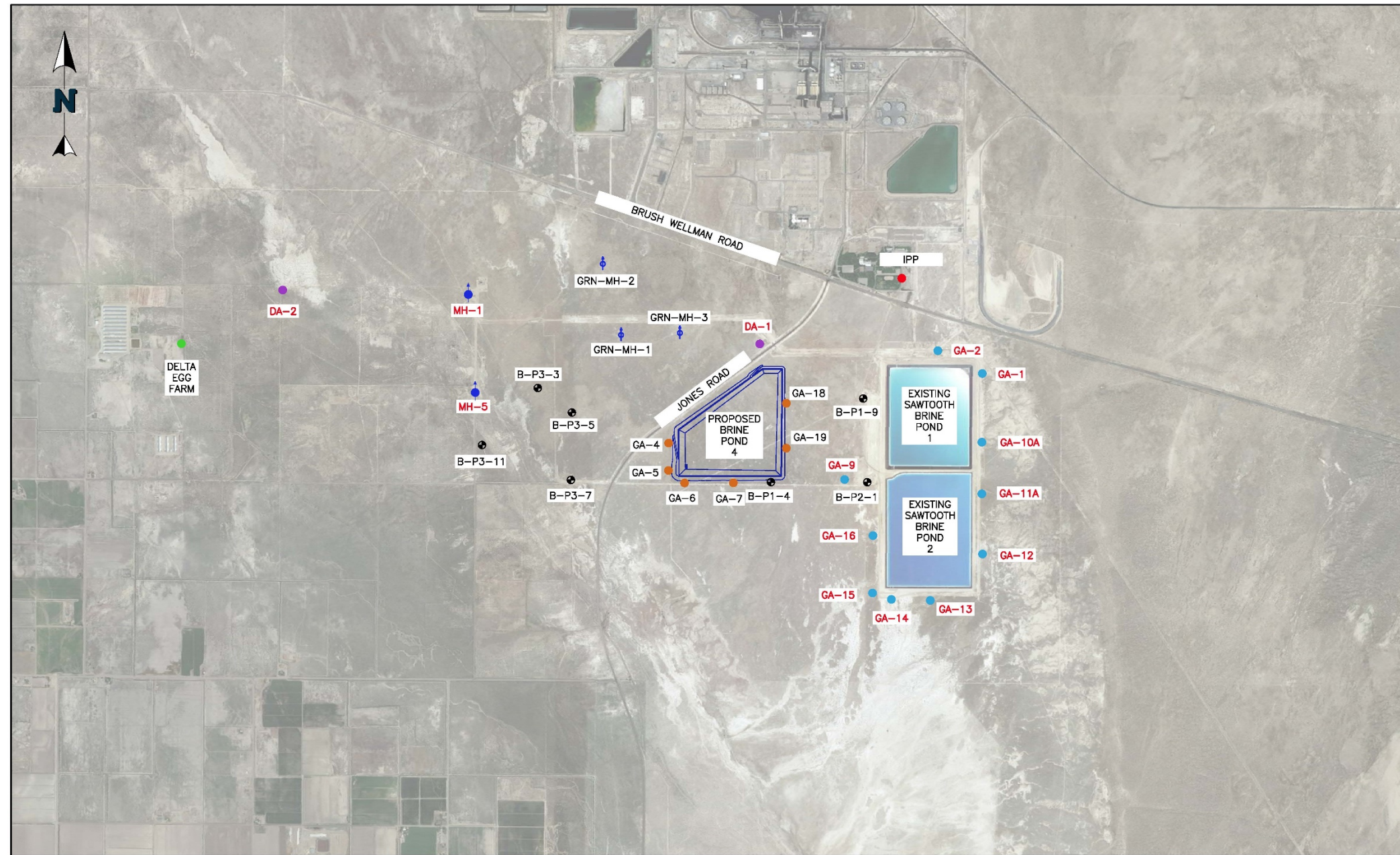

LEGEND:

- PROPOSED BRINE POND
- GA-4 PROPOSED WATER TABLE AQUIFER MONITORING WELL
- GRN-MH4 PROPOSED DEEP ARTESIAN AQUIFER WATER PRODUCTION WELL

EXISTING SAWTOOTH WELLS:

- GA-1 WATER TABLE AQUIFER MONITORING WELL
- MH-1 BASEMENT AQUIFER WATER PRODUCTION WELL
- DA-2 MULTI-AQUIFER MONITORING WELL

OTHER WELLS:

- DELTA EGG FARM SHALLOW ARTESIAN AQUIFER WATER PRODUCTION WELL
- IPP DEEP ARTESIAN AQUIFER WATER PRODUCTION WELL
- B-P1-4 MAGNUM WATER TABLE AQUIFER MONITORING WELL

NOTES:

1. AERIAL IMAGE WAS OBTAINED FROM GOOGLE EARTH AND IS DATED AUGUST 19, 2019

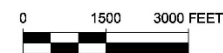

	CLIENT	MAGNUM SOLUTION MINING, LLC	
	PROJECT	BRINE POND 4	
TITLE	AQUIFER MONITORING WELL NETWORK	FILENAME	475.0093.020.GWDP.1-1
		FIGURE NO.	APP.D.2
		REVISION	B

Figure 2 - Aquifer Monitoring Well Network

This page left intentionally blank.

Section 2

Groundwater Monitoring Methods

Baseline data for the groundwater system that the facility will be producing from has been collected since 2009. Baseline data collection for groundwater level in the shallow artesian, deep artesian, and basement aquifers was first initiated in 2009 when MH-1 was first drilled and developed, and has continued as MH-5, DA-1 and DA-2 have been drilled and developed. (Water production wells MH-1 and MH-5, and the multi-aquifer monitoring wells DA-1 and DA-2, were previously owned by the Company). Data collection for groundwater level baseline conditions also includes data collected since 2009 from an Intermountain Power Agency (IPA) industrial water well, a private commercial water well owned by the Delta Egg Farm, and a well installed and monitored by the U.S. Geological Survey (USGS). Baseline data for groundwater levels and quality of the water table aquifer directly beneath the brine evaporation ponds have been collected since 2010. These baseline conditions are kept on file at the facility and are incorporated into the required agency reporting as necessary.

2.1 Storage Cavern Field Groundwater Level Monitoring Methods

The facility will conduct groundwater level monitoring in association with the storage caverns using a network of proposed and existing groundwater production and observation wells that are located both within the facility and off-site. The wells within the facility that will be used to monitor groundwater levels are the planned production wells GRN-MH-1 through GRN-MH-3 as they are drilled and put into service. The off-site wells that will be used to monitor groundwater levels include Sawtooth's MH-1 and MH-5 water production wells and observation wells DA-1 and DA-2, an industrial water well owned by the Intermountain Power Agency (IPA), and a private commercial water well owned by the Delta Egg Farm. Figure 2 depicts the location of all the wells that will be used for groundwater level monitoring. This network of wells will allow the Company to monitor groundwater levels in the shallow artesian, deep artesian, and basement aquifers. Figure 1 illustrates the individual well depths and monitoring points in relation to the groundwater system. Note that the Company will only be able to monitor the groundwater aquifer conditions from the off-site locations with landowner cooperation.

Existing monitoring wells are equipped with transducers to measure groundwater levels; future wells will be similarly equipped. The transducers are installed within monitoring tubes located within the production casings of the individual wells. Each of the Sawtooth, Delta Egg Farm and the IPA water wells each have a single monitoring tube installed to monitor the respective aquifer in which each well is completed. DA-1 and DA-2 are equipped with monitoring tubes that enable monitoring of shallow artesian, deep artesian, and basement aquifers.

The data loggers connected to each transducer have been set to record groundwater level measurements daily. Data from the transducers at each monitoring well will be downloaded and analyzed monthly during periods of solution mining. Groundwater level measurements will be documented to the nearest 0.1 foot. The functionality of transducers will be checked monthly the first year of operations and quarterly thereafter; adjustments to transducer settings will be made accordingly. Table 2 summarizes the groundwater level monitoring schedule as described above.

Table 2: Storage Cavern Field Groundwater Level Monitoring Schedule

Well	Aquifer Monitoring Point	Data Collection Interval	Data Download and Analysis Frequency¹
GRN-MH-1 – GRN-MH-3 Water Production Wells ²	Deep artesian	Daily	Monthly
Sawtooth DA-1 and DA-2 Observation Wells ³	Shallow artesian, deep artesian, and basement	Daily	Monthly
Sawtooth MH-1 and MH-5	Basement	Daily	Monthly
IPA Water Production Well ⁴	Deep artesian	Daily	Monthly
Delta Egg Farm Water Production Well ⁵	Shallow artesian	Daily	Monthly
USGS Well	Shallow artesian	Daily	As available ⁶

¹Data will be downloaded and analyzed monthly during periods of solution mining, quarterly otherwise.

²Planned Company-owned wells.

³Wells owned by Sawtooth NGLs, LLC. Owner permission required to monitor.

⁴Well owned by Intermountain Power Agency. Owner permission required to monitor.

⁵Well owned by Delta Egg Farm. Owner permission required to monitor.

⁶Data recorded daily by USGS but made publicly available at irregular intervals, approximately every six months.

2.2 Storage Cavern Field Groundwater Quality Monitoring Methods

The Company will conduct groundwater quality monitoring in association with the hydrogen storage caverns using the planned production wells GRN-MH-1 through GRN-MH-3. These wells are proximal to the storage cavern field and will produce water from the deep artesian aquifer at elevations between 700 to 1,400 feet bgs (see Figures 1 and 2).

Groundwater samples will be collected monthly from GRN-MH-1, GRN-MH-2, and GRN-MH-3. Groundwater sampling methods will be per the Groundwater Sampling Quality Assurance Procedures included as Appendix A. The sampling methods include:

- Water samples will be collected from the sample port that is closest to each wellhead.
- A hand-held multi-gas meter will be used to monitor the headspace of each well for the presence of combustible gas, including but not limited to hydrogen and hydrocarbons, prior to sampling. If combustible gas is detected, subsequent analysis can be done.
- The water level will be measured prior to sampling.
- Samples will be collected directly into laboratory-provided containers and delivered per the laboratory-required protocols.
- Information pertinent to the sampling effort will be documented on preprinted field sheets.
- The handling of all samples collected will be traceable from the time of collection, through analysis, until final disposition. Documentation of the sample history is referred to as chain-of-custody.

- Samples will be sent to and analyzed by a State of Utah certified laboratory for the analysis of sodium, chloride, and total dissolved solids.

Table 3 summarizes the groundwater quality monitoring schedule associated with the storage caverns as described above.

Table 3: Storage Cavern Field Groundwater Quality Monitoring Schedule

Well	Aquifer Monitoring Point	Water Sample Frequency
GRN-MH-1 – GRN-MH-3 water production wells ¹	Deep artesian	Monthly

¹ Planned facility-owned wells.

2.3 Brine Evaporation Ponds Groundwater Quality Monitoring Methods

The Company will conduct groundwater quality monitoring of the water table aquifer in association with the brine evaporation ponds using the proposed monitoring wells GA-4, GA-5, GA-6, GA-7, GA-18, and GA-19. Following an accelerated sampling program and data evaluation, this list might be modified. These wells are placed in an array around and on the berms of the brine evaporation ponds (see Figure 2). All wells will be installed to a depth within the water table aquifer zone (see Figure 1 and Figure 2). GA-18 and GA-19 are intended to monitor upgradient groundwater quality of the brine evaporation ponds; the remaining wells are intended to monitor groundwater quality downgradient of the ponds. Water level measurements also will be taken during monitoring events.

Groundwater monitoring of the water table aquifer will be conducted in accordance with the requirements of the DWQ GWDP. The water table aquifer groundwater monitoring plan includes

- Monthly field parameter data collection for pH, temperature, TDS, and conductivity; and,
- Quarterly laboratory analysis for the parameters identified in Table 4.

In accordance with DWQ GWDP #(Insert New Permit Number), the Company will conduct field monitoring monthly for the parameters above. Monthly field monitoring will be conducted for a period of 24 months after the initiation of commercial operations. After the first 24 months of commercial operations, the frequency of field monitoring will be reduced to quarterly.

In addition, the DWQ GWDP requires Accelerated Background Monitoring on a quarterly basis for a period of 24 months to establish ground water protection levels for the storage facility. Accelerated Background Monitoring will initially include both the collection of field parameters and collection of groundwater samples for laboratory analysis on a quarterly basis for the parameters above. Analysis of all groundwater samples will be performed by laboratories certified by the Utah Department of Health, will follow methods cited in Utah Administrative Code (UAC) R317-6-6.3L, and will ensure that method detection limits are less than the Interim Ground Water Protection Levels for the water table aquifer zone described in Table 4.

After completion of the Accelerated Background Monitoring, the Company will submit an Accelerated Background Monitoring Report to the DWQ. After review and approval of the Accelerated Background Monitoring Report, the Director of DWQ (the Director) will establish

well-specific groundwater protection levels for each parameter in accordance with R317-6-4 of the Ground Water Quality Protection Rules. After specific well protection measures have been identified, sampling will be reduced to a semi-annual frequency.

Table 4: DWQ Interim Groundwater Protection Levels

Parameter	Protection Level (mg/L)
pH (units)	6.5 – 8.5 ¹
Chloride	150
Sodium	200
Total Dissolved Solids	750

¹Class II Groundwater Quality Standard

Table 5 summarizes the groundwater quality monitoring schedule for the evaluation of the DWQ Groundwater Quality Standards in the vicinity of the brine evaporation pond.

Table 5: Brine Evaporation Pond Groundwater Quality Monitoring Schedule

Well	Aquifer	Field Monitoring (0-24 mos.)	Field Monitoring (after 24 mos.)	Accelerated Background Monitoring (0-24 mos.)	Compliance Monitoring (after 24 mos.)
GA Monitoring Wells	Water table aquifer	Monthly	Quarterly	Quarterly	Semi-annual

2.3.1 Exceedances

Upon exceedance in a downgradient monitoring well of any one parameter listed in Table 4, the monitoring well(s) in which the exceedance was(were) detected will immediately be resampled for laboratory analysis of the exceeded protection level parameter(s). The analytical results will be submitted to the DWQ, and the Director will be notified of a probable out-of-compliance status within 30 days of the initial detection.

Upon exceedance of any one parameter listed in Table 4 for two consecutive sampling events, the Company will immediately notify the DWQ and Millard County and implement an accelerated schedule of monthly sampling and analysis. This monthly schedule will continue for at least two months or until the compliance status can be determined by the Director. Reports of the results of this sampling will be submitted to the Director as soon as they are available, but not later than 30 days from each date of sampling.

If the protection level for a parameter listed in Table 4 is exceeded in two consecutive samples from a compliance monitoring well, the well is out of compliance. The Director will be notified verbally of the exceedance within 24 hours of the receipt of data demonstrating out-of-compliance status; written notice will be provided within 5 days. Accelerated monthly groundwater monitoring will continue for at least two months, and until the facility is brought into compliance, or as determined by the Director.

Within 30 days after the written notice to the Director of out-of-compliance status, the Company will submit an assessment study plan and compliance schedule for:

- 1) Assessment of the source or cause of the contamination, and determination of steps necessary to correct the source.
- 2) Assessment of the extent of the ground water contamination and any potential dispersion.
- 3) Evaluation of potential remedial actions to restore and maintain ground water quality and ensure that the ground water standards will not be exceeded at the compliance monitoring wells.

Millard County will be immediately notified of any monitoring well that is out of compliance.

Section 3

Agency Reporting and Notification

3.1 Storage Cavern Field Groundwater Level Reporting and Notification

During the first year of solution mining, the Company will submit monthly water level measurement reports to Millard County during periods of solution mining. The reports will include water level as measured in depth to ground water from the surveyed casing measuring point, and ground water elevations as converted by casing measuring point elevations. The report will also include a graphical depiction of the water level data from all monitored wells. The Company will also submit an annual Water Rights and Water Usage Summary and Analysis to the State Engineer and Millard County by April 30 for the previous year in which solution mining activities have been conducted.

The facility managers will initiate a detailed internal review with a professional engineer/hydrogeologist if a sustained change in water levels greater than 12 feet below the historic recorded low is documented within the shallow and deep artesian aquifers in off-site monitoring wells. Once the internal review is complete, facility managers will meet with the owner of the off-site well, the Company or facility's professional engineer/hydrogeologist, and the State Engineer to review and coordinate any necessary action. The Company will notify Millard County of any official determination made by the State Engineer.

3.2 Storage Cavern Field Groundwater Quality Reporting and Notification

The Company will prepare and file quarterly groundwater quality monitoring reports with the required agencies. The reports will include the groundwater analysis results and groundwater level measurements for each monitoring well. Reports will be submitted per the following schedule:

- First Quarter Report (January, February, March) – Due April 30.
- Second Quarter Report (April, May, June) – Due July 31.
- Third Quarter Report (July, August, September) – Due October 31.
- Fourth Quarter Report (October, November, December) – Due Jan 31.

The Company will immediately consult with agencies on an appropriate course of action if:

- Sodium or chloride concentrations measured in a groundwater sample are higher than the baseline concentrations by a factor of two.
- Combustible gases traceable to storage products are detected in the headspace of a well.

3.3 Brine Evaporation Pond Groundwater Quality Reporting and Notification

Quarterly groundwater quality monitoring reports will be submitted to the required agencies per the following schedule:

- First Quarter Report (January, February, March) – Due April 30.

- Second Quarter Report (April, May, June) – Due July 31.
- Third Quarter Report (July, August, September) – Due October 31.
- Fourth Quarter Report (October, November, December) – Due Jan 31.

The Company will also submit an Accelerated Background Monitoring Report to the required agencies per the requirements of the DWQ GWDP after eight quarterly sample events have been completed. The report will include all field data sheets (see Appendix B), laboratory analytical reports, and the following statistical calculations by well, presented in spreadsheet format for the interim groundwater protection parameters listed in Table 4.

- Non-detect values converted to the detection limit times 0.25
- Mean concentration
- Standard deviation
- Mean concentration plus 2 standard deviations
- Mean total dissolved solids concentration times 1.25
- Mean concentration of all other parameters times 1.25
- Ground water quality standard times 1.25

After Accelerated Background Monitoring is completed and the Director establishes well-specific groundwater protections parameters, ongoing groundwater quality monitoring reports will include the following information:

- Field Data Sheets (see Appendix B), or copies thereof, including the field measurements required as identified in Section 3.3 above, and other pertinent field data, such as well name/number, date and time, names of sampling crew, depth to water, type of sampling pump or bail, volume of water purged before sampling.
- Laboratory Analytical Results, including date sampled, date received; and the results of analysis for each parameter, including the value or concentration, units of measurement, reporting limit (minimum detection limit for the examination), analytical method, and the date of the analysis.
- A summary table of the analytical results from the current and previous monitoring events, a discussion of whether the monitoring wells comply with groundwater protection parameters, an evaluation of temporal and spatial trends in the data, a discussion laboratory data quality assurance/quality control, and any other information pertinent to the monitoring even.

3.4 Brine Evaporation Pond Leak Detection System Reporting, Notification, and Corrective Action

Leak detection system (LCRS and PCMS) monitoring will be reported monthly. The reports will be submitted to the required agencies and will include:

- A verification that the inspection schedule is being maintained;
- A verification that the measured LCRS and PCMS Maximum Allowable Leakage rates in Table 6 below have not been exceeded;
- The volume of fluid pumped from the LCRS and PCMS sumps, tabulated either daily or monthly depending on the monitoring interval;
- The disposition of any fluids pumped from the LCRS and PCMS sumps; and,
- If the Maximum Allowable Leakage Rates have been exceeded, the Director will be notified verbally as soon as possible, but no later than 24 hours after the Company becomes aware of the exceedance. The report shall be made to the Utah Department of Environmental Quality 24-hour number, (801) 536-4123, or to the Division of Water Quality, Ground Water Protection Section at (801) 536-4300, during normal business hours (Monday through Friday 8:00 am - 5:00 pm Mountain Time).
- Electronic and written submission will also be provided to the Director within five days of the time that the Company becomes aware of the exceedance. The electronic data in the format specified by the Director (e-mail, compact disc, or another approved transmittal mechanism). The written submission will contain:
 - A description of the exceedance and its cause;
 - The period of exceedance, including exact dates and times;
 - The estimated time the exceedance is expected to continue if it has not been corrected; and,
 - Steps taken or planned to reduce, eliminate, and prevent reoccurrence of the exceedance.
- Out-of-compliance conditions will be evaluated by daily monitoring of pumping rates from the LCRS and PCMS sumps during the filling of the pond.
 - A sudden spike in flows indicates one or more leaks. Filling will be halted, and the pond will be inspected to determine the source of the leaks.
 - After the leak(s) is(are) identified and repaired, filling will continue, while continuing to monitor flows.
- After the pond has been filled and leakage rates stabilize or decline, the pumping rate of fluids pumped from the LCRS and PCMS sumps and returned to the pond will be monitored weekly and compared to the Maximum Allowable Leakage Rates.
- The maximum head in the LCRS sump will be managed by pumping leakage collected in sump back into the pond. Fluid will be pumped from the sump such that it is not necessary to pump at a rate greater than the Action Leakage Rates in Table 6 below.

- If a leak develops after filling the pond, the first step will be to monitor head in the space between the liners to narrow the location of the leak(s) to allow focused inspections and to confirm that head has been controlled between the liners.
 - If elevated head between the liners is identified as the source of leakage, head control will be reestablished as described in the Brine Evaporation Ponds Operating Manual.
 - If excessive leakage occurs because of a liner failure, the liner will be repaired prior to introducing additional fluids into the pond.

Table 6: Brine Evaporation Pond Maximum Allowable Leakage Rates

Monitoring System Component	Maximum Allowable Leakage Rate	Action Leakage Rate¹
LCRS Sump	460 gallons per minute	370 gallons per minute
PCMS Sump	14.0 gallons per minute	11.2 gallons per minute

¹The Action Leakage Rate for each component is 80 percent of the respective Maximum Allowable Leakage Rate.

This page left intentionally blank.

Section 4

Record Retention

4.1 Records

The Company will retain copies at the storage facility of all monitoring data sheets, laboratory analyses and agency reports associated with groundwater level, water quality, and leak detection system monitoring. These records will be kept for the operational life of the facility.

This page left intentionally blank.

Appendix A
Groundwater Sampling Quality
Assurance Procedures

GROUNDWATER SAMPLING QUALITY ASSURANCE PROCEDURES

1.0 SAMPLING PROCEDURES

Groundwater samples will be collected monthly from production wells GRN-MH-1, GRN-MH-2, and GRN-MH-3, and analyzed for sodium, chloride, total dissolved solids, and dissolved gases. Groundwater samples from the water table aquifer monitoring wells GA-4, GA-5, GA-6, GA-7, GA-18, and GA-19 will be collected monthly initially, moving to semi-annually. Sampling events will be documented on field forms and reported in quarterly reports. Basic sampling procedures are as follows:

- Prior to sampling GRN-MH-1, GRN-MH-2, and GRN-MH-3, a hand-held multi-gas meter will be used to monitor the headspace of each well for the presence of combustible gases, including but not limited to hydrogen and hydrocarbons.
- Prior to sampling all monitoring wells, water levels also will be measured.
- Groundwater sampling will be performed by collecting a sample directly from the sample port that is closest to each wellhead in the case of GRN-MH-1, GRN-MH-2, and GRN-MH-3. In the case of the GA wells, sampling will be performed directly from the well.
- Each well will be purged prior to sampling. A minimum of three volumes of water in the well casing will be removed, unless the well runs dry. A well that runs dry will be revisited and sampled once the water level has recovered and sufficient water is available for sampling.
- Because exact flow rates are unknown, the well pumping and sampling point purge rates will be recorded.

2.0 SAMPLING QUALITY CONTROL

The quality control (QC) objective is to ensure that data are not biased by contamination or sampling error.

To meet this objective, the following QC samples will be collected in the field:

- Field duplicates will be collected with a minimum of 1 for every 10 samples. Field duplicates will be collected from the same source at the same time as the primary sample. The field duplicate will be labeled differently than the parent sample in order to appear as a separate sample to the analytical laboratory.

Matrix spike/matrix spike duplicate (MS/MSD) samples will not be collected. MS/MSDs will be analyzed by the analytical laboratory for each batch of samples run, but not necessarily from the samples collected at the site.

3.0 FIELD DOCUMENTATION

Information pertinent to the sampling effort will be documented on preprinted field sheets or bound logbooks. All entries will be made in indelible ink and all corrections will be made by drawing one line through the error and initialing and dating the correction.

At a minimum, entries on field documentation will include the following:

- Date,
- Project,
- Identification of sampling team members, and,
- Location and description of sampling points.
- Static water levels,
- Date and time of sample collection,
- Sample identification,
- Sampling methodology,
- Field observations, and
- Field instrument calibration results.

Documentation will contain sufficient information to reconstruct the sampling activity without relying on the sampler's memory. The field documentation will be kept on file at the sampling contractor's office.

4.0 DECONTAMINATION PROCEDURES

Because no field equipment will come into contact with groundwater samples, decontamination procedures are not required.

5.0 SAMPLE ANALYSIS AND CONTAINERS

Samples will be analyzed by a Utah certified laboratory for the following:

- Sodium by USEPA Method 200.7;
- Chloride by USEPA Method 300.0;
- Total Dissolved Solids by USEPA Method SM2540C; and
- Dissolved Gases by USEPA Method
- or equivalent.

6.0 SAMPLE HANDLING

At the time of sample collection, labels will be affixed to the sample containers. These labels will contain the following information:

- Sample identification number,
- Date and time of sampling,
- Preservative,

- Analyses requested, and
- Name of sampler.

Samples will be collected directly into laboratory-provided containers and placed on ice in an insulated cooler. All samples will be identified, labeled, and logged onto a chain-of-custody (COC) form, and handled under standard COC protocol. Samples will be considered to be under a person's custody if they remain:

- In a person's physical possession,
- In view of the person after he/she has taken possession,
- Secured by that person so that no one can tamper with the sample, or
- In a secure area accessible only to authorized personnel.

To establish the documentation necessary to trace sample possession from the time of collection, the COC record must be completed and accompany every sample shipment. At a minimum, COC records should contain the following information:

- Project name,
- Sample identification,
- Date and time of sample collection,
- Type of matrix,
- Number of containers,
- Preservative,
- Analyses requested,
- Method of shipment,
- Signature of sampler, and
- Date and time of each change in custody.

Each person who has custody of the samples will sign the record. The completed COC record will be sealed in a waterproof plastic bag and placed inside the sample cooler. The sampler will keep a copy of each COC record. Custody seals will be affixed to the front and back of the cooler and covered with clean tape during storage and shipping operations.

The laboratory will assess the integrity of the custody seals upon sample arrival. The laboratory will also verify and document the following information upon sample receipt:

- Condition of the shipping container,
- Condition of the sample container(s),
- Condition of the custody seals,
- Presence/absence of custody seals,
- Presence/absence of custody records,

- Presence/absence of sample labels,
- Agreement/non-agreement of documents,
- Cross-reference of laboratory numbers, and
- Temperature inside the shipping container.

The laboratory will document any problems or discrepancies with the samples or custody documents, contact the sampling organization, and document the resolution to the problems or discrepancies.

The laboratory completing chemical analyses will be required to maintain samples in a secure location with limited access from the time of sample receipt through sample disposal. Samples collected during this investigation will be either shipped to the laboratory via an overnight carrier or will be hand delivered to the analytical laboratory. If the samples are shipped via an overnight carrier, the following procedure will be used for packaging:

- Inert cushioning material will be placed in the bottom of the cooler.
- The cooler will be lined with a large plastic bag.
- Each sample container will be sealed in a resealable plastic bag and placed upright in the cooler.
- For all coolers containing samples that require 4°C preservation, blue ice or wet ice and additional packaging materials will be placed around the containers. Wet ice will be double bagged.
- A temperature blank will be included in each cooler containing samples that require 4°C preservation.
- Pertinent paperwork such as the COC form will be placed in a re-sealable plastic bag and taped to the inside lid of the cooler.
- Signed custody seal will be attached to the cooler in two places and covered with clear tape in such a way that the custody seal must be broken to open the cooler.
- The cooler will be sealed with packaging tape.

A shipping label will be affixed to the outside of the cooler.

Appendix B

Monitoring Forms

**BRINE POND 4 MONITORING FORM
MAGNUM SOLUTION MINING, LLC
DELTA, UTAH**

Well I.D. and Depth of Well (DOW)	DATE mm/dd/yy	DTW (feet)	Water Column Thickness	Total Gallons Removed	TEMP. (°C)	Specific Conductance (µS/cm ³)	Conductivity (ohms)	Salinity (ppt)	TDS (mg/L)	pH	NOTES
GA-4 (TBD)											
GA-5 (TBD)											
GA-6 (TBD)											
GA-7 (TBD)											
GA-18 (TBD)											
GA-19 (TBD)											
Brine Pond Sump Monitoring											
LCRS Sump											
Water Present Y / N	Conductivity (ohms)		Salinity (ppt)		Flow Rate (GPM)		Meter Reading (gal)				
PCMS Sump											
Water Present Y / N	Conductivity (ohms)		Salinity (ppt)		Flow Rate (GPM)		Meter Reading (gal)				
Sump Equipment Inspection and Performance Verified				Y / N	Allowable Leakage Rate for the Pond Liner System Verified				Y / N		
Field Data Collection and Sample Collection Instructions											
Field Data Parameter Collection Instructions											
Step 1) Calibrate YSI meter prior to each use (follow instructions in manual)											
Step 2) Measure depth to groundwater with water interface probe											
Step 3) Calculate well volume to be removed from each well using Purge Volume Table and remove the calculated volume											
Step 4) Collect field parameter readings upon completion of Step 3 and record any unusual circumstances in the "NOTES" column above											
Step 5) Collect field parameter readings from sumps											
Groundwater Sampling Instructions											
Step 6) Upon completion of Step 4 collect groundwater samples from each well											
Step 7) Fill appropriate laboratory provided containers											
Step 8) Complete Laboratory Chain of Custody (see attached example)											
Laboratory Analysis Requirements											
Sodium by Method 200.7, Plastic Pint Container Preserved with HNO ₃											
Chloride by Method 300, Total Dissolved Solids (TDS) by Method SM-2540C, and pH, all collected in a 1/2 gallon plastic container with no preservative.											
COMMENTS											

**BRINE POND 4 FIELD MONITORING FORM
MAGNUM SOLUTION MINING, LLC
DELTA, UTAH**

Well I.D.	DATE mm/dd/yy	DTW (feet)	Flow Rate (gpm)	Draw Down (ft)	Headspace Gas (LEL)	TEMP. (°C)	Specific Conductance ($\mu\text{S}/\text{cm}^2$)	Conductivity (ohms)	Salinity (ppt)	TDS (mg/L)	pH	NOTES
GRN-MH-1												
GRN-MH-2												
GRN-MH-3												
DA-1 Shallow												
Deep												
Basement												
DA-2, Shallow												
Deep												
Basement												
Delta Egg Farm Well												
IPA												

Field Data Collection and Sample Collection Instructions

Field Data Parameter Collection Instructions

Step 1) Calibrate YSI meter prior to each use (follow instructions in the equipment manual)

Step 2) Calibrate combustible gas meter prior to each use (follow instructions in the equipment manual)

Step 3) Measure combustible gas levels in GS-MH-1, GS_MH-2, GS-MH-3, GS-MH-4, and GS-MH-5 with portable combustible gas meter

Step 4) Measure depth to groundwater manually using the water interface probe in GS-MH-1, GS_MH-2, GS-MH-3, GS-MH-4, and GS-MH-5

Step 5) Collect field parameter readings and record any unusual circumstances in the "NOTES" column above

Step 6) Confirm functionality of the water level transducers and download water table elevation data from each well to the laptop computer

Step 7) Manually record WTE data from DA wells, and the Egg Farm and IPA Wells

Groundwater Sampling Instructions

Step 7) Follow Steps 1-6 above. Collect groundwater samples from GS-MH-1, GS_MH-2, GS-MH-3, GS-MH-4, and GS-MH-5 in the laboratory-provided containers

Step 8) Complete Laboratory Chain of Custody (see attached example)

Laboratory Analysis Requirements

Sodium by Method 200.7, Plastic Pint Container Preserved with HNO_3

Chloride by Method 300, Total Dissolved Solids (TDS) by Method SM-2540C, and pH, all collected in a 1/2 gallon plastic container with no preservative.

Data Submittal

At the completion of each monthly data collection effort send electronic depth-to-water data to ATC Associates (jim.coletta@atcassociates.com).

COMMENTS

APPENDIX C

COOLING AND BLOWDOWN WATER POND OPERATING
MANUAL
(PENDING PUBLICATION)

GROUND WATER QUALITY DISCHARGE PERMIT UGW270014

STATEMENT OF BASIS

Advanced Clean Energy Storage I, LLC
Cooling and Blowdown Water Pond
Holladay, UT

March 2024

Introduction

The Division of Water Quality (DWQ) under the authority of the Utah Ground Water Quality Protection Rules ¹(Ground Water Rules) issues ground water discharge permits to facilities which have a potential to discharge contaminants to ground water². As defined by the Ground Water Rules, such facilities include mining operations. ³The Ground Water Rules are based on an anti-degradation strategy for ground water protection as opposed to non-degradation; therefore, discharge of contaminants to ground water may be allowed provided that current and future beneficial uses of the ground water are not impaired and the other requirements of Rule 317-6-6.4.A are met.⁴ Following this strategy, ground water is divided into classes based on its quality⁵; and higher-quality ground water is given greater protection⁶ due to the greater potential for beneficial uses.

DWQ has developed permit conditions consistent with R317-6 and appropriate to the nature of the mined materials, facility operations, maintenance, best available technology⁷ (BAT) and the hydrogeologic and climatic conditions of the site, to ensure that the operation would not contaminate ground water.

Basis for Permit Issuance

Under Rule 317-6-6.4A, DWQ may issue a ground water discharge permit if:

- 1) The applicant demonstrates that the applicable class TDS limits, ground water quality standards protection levels and permit limits established under R317-6-6.4E will be met;
- 2) The monitoring plan, sampling and reporting requirements are adequate to determine compliance with applicable requirements;
- 3) The applicant is using best available technology to minimize the discharge of any pollutant; and

¹ Utah Admin. Code Rule 317-6

² https://deq.utah.gov/ProgramsServices/programs/water/groundwater/docs/2008/08Aug/GWQP_PermitInfo.pdf

³ Utah Admin Code Rule 317-6-6.1A

⁴ Preamble to the Ground Water Quality Protection Regulations of the State of Utah, sec. 2.1, August, 1989

⁵ Utah Admin. Code Rule 317-6-3

⁶ Utah Admin. Code Rule 317-6-4

⁷ Utah Admin. Code Rule 317-6-1(1.3)

- 4) There is no impairment of present and future beneficial uses of ground water.

Purpose

Advanced Clean Energy Storage I, LLC (ACES) is constructing a hydrogen production and storage facility in Millard County, Utah approximately 10 miles north of Delta. The Project entails solution mining storage caverns in a subsurface salt deposit for the purpose of storing hydrogen. The hydrogen to be stored will be produced on-site at a to be constructed hydrogen production facility. The cooling and blowdown waste water will be stored for evaporation in an above-ground lined pond. The Project lies within an approximately 321-acre site located on Utah School and Institutional Trust Lands Administration (SITLA) lands.

Ground Water Discharge Permit UGW270014 is being issued to authorize the construction of one cooling and blowdown water evaporation pond and the installation of additional unconfined water table aquifer compliance monitoring wells. Ground Water Discharge Permit UGW270014 is being issued with the associated construction permit for the construction of the pond.

New Facilities

The following new facilities will be regulated under this Permit including the associated Best Available Technology (BAT), Protection Levels (Table 2) and requirements for monitoring the cooling and blowdown water pond.

The cooling and blowdown water pond footprint is approximately 34 acres with a storage area measured three feet below the crest of the berm of approximately 25 acres. The cooling and blowdown water pond is constructed using a combination of excavation into the ground surface and the construction of elevated berms.

The cooling and blowdown water pond is constructed with a single 60-mil high-density polyethylene liner. The liner will be sitting on top of the leak collection and infiltration prevention (LCIP) system. The system consists of four quadrants, each with lined drainage collection swales, trenches, and a sump. The LCIP system will capture and direct to the sumps, leakage from the primary single liner. The sumps will be monitored and pumped back into the pond to provide a leak detection measurement and to limit infiltration from the primary liner.

The pond will have a set of compliance monitoring wells installed up and down-gradient of the berm walls for the protection of groundwater. The berms will have piezometers installed which will be monitored for liquid levels in the berms as an additional leak detection tool.

BAT Performance Monitoring

Best available technology monitoring will include minimum vertical freeboard and maximum allowable leakage rate monitoring. These performance standards are based on the precedence of previous groundwater discharge permits and *Action Leakage Rates For Leak Detection Systems* (USEPA, Office of Solid Waste, January 1992).

Minimum Vertical Freeboard. A minimum of 36 inches of vertical freeboard shall be maintained to ensure total containment of solution mining liquids.

Maximum Allowable Leakage Rate. The leak detection system is the primary compliance monitoring point because it is the early warning system that demonstrates protection of ground water quality. The estimated maximum liner leakage rate was established by standard engineering practice using the method described in *Equations for Calculating the Rate of Liquid Migration through Composite Liners due to Geomembrane Defects* (Giroud, 1997). Based on a pond water surface area of approximately 25 acres, the maximum allowable leakage rate through the primary HDPE liner is 8 gallons per minute.

Maximum Allowable Head. The maximum allowable head imposed on the leak detection sumps will be determined following system construction. Any fluids collected in the leak detection sump will be pumped back to the brine evaporation ponds. As long as the leak detection system complies with the BAT performance standards of the permit, the facility is compliant. In the event that the leak detection system has flows or heads that exceed the BAT performance standards of the permit, a BAT failure exists and the permittee will be required to regain BAT by a number of solutions including identifying and repairing the BAT failure.

Potential Impacts to Ground Water

Potential impacts to ground water have been minimized by employing best available technology for the cooling and blowdown water pond. The Division of Water Quality will provide periodic onsite inspections during construction and operation of the facilities described above. The Cooling and Blowdown Water Pond Operating Manual/Standard Operating Plan will ensure that the facility is operated in accordance with design specifications and will also ensure that any indications of facility problems will be detected early and resolved. In addition to BAT performance monitoring, ground water quality monitoring of the water table aquifer will be conducted in monitoring wells to determine if ground water quality has been impacted by leakage from the brine evaporation pond.

Geologic Description

Regional. The brine evaporation pond is situated over a subsurface salt deposit in the Sevier – Black Rock Desert in the Basin and Range physiographic province of Utah. The mountains that surround the basin of the Sevier Desert are composed of a variety of consolidated sedimentary, metamorphic and igneous rock. The basin is underlain by deposits that consist primarily of semi-consolidated and unconsolidated sediments of Tertiary and Quaternary age. The basin-fill includes sand, silt, clay and gravel deposited as alluvial fans, stream alluvium, mudflows, lacustrine (lake) sediments and deltas. The basin fill also contains scattered basalt flows and tuffs of late Tertiary and Quaternary age. Tertiary and Quaternary basin-fill deposits are over 7,000 feet thick. Oligocene and Miocene basin-fill sediments contained evaporate deposits. Through time, evaporites in the area flowed to form a salt dome.

The soil profile at the site consists of three units. The upper unit is comprised of fine-grained glacial lacustrine deposits consisting of deep-water calcareous silts and may contain younger alluvium up to 10 feet thick. The upper unit is underlain by pre-Lake Bonneville alluvium consisting of sand and sandy gravel beds. The lower unit consists of alluvium, silt and sandy silt deposited in large low-gradient alluvial fans, river terraces, and abandoned river channels on the river delta. This unit ranges up to 30 feet in thickness.

Hydrogeology

The principal regional groundwater system is the unconsolidated basin-fill deposits that formed from erosion of the surrounding mountains and were laid down by streams, lakes, and mudflows. These regional deposits consist of interbedded and lenticular deposits of clay, silt, sand, gravel and boulders. The regional depositional processes created alternating and interfingering layers and lenses with regional horizontal and vertical heterogeneity. Differences in sorting and grain size influence local permeability and storage capacity, which can vary greatly depending on the nature of local depositional processes. Sediments are generally coarser near the mountain front and grade finer towards the valley centers. Stream channel deposits are coarser and better sorted than alluvial fan and mudflow deposits that generally occur at the base of steep drainages. Vast lakes that occupied the valleys many thousands of years ago deposited interbedded clay and finegrained sands. Rivers flowing into these lakes formed coarse-grained delta deposits near the ancient lake shore, such as near the mouth of Leamington Canyon.

Recharge to the principal groundwater aquifer system (basin-fill deposits) in the Sevier Desert occurs by stream infiltration along mountain fronts, subsurface inflow from consolidated rocks of mountain areas, subsurface inflow from adjoining basins, seepage from rivers, canals, reservoirs and unconsumed irrigation. Groundwater generally flows from recharge areas near the mountains on the northeast and east of the Sevier Desert toward discharge areas in the central and western parts of the area.

Aquifers in the area have been clearly defined using data collected during the installation of multiple wells constructed in the region around the Magnum and ACES site, including

Magnum's MH-1 Test Well (constructed in 2009). The unconfined water table aquifer is located above the shallow artesian aquifer and is generally confined to the upper 50 to 150 feet, the shallow artesian aquifer to depths of about 150 to 700 feet, and the deep artesian aquifer between about 700 to 1,400 feet (the bottom of historically drilled wells). A previously undefined deeper confined aquifer (defined as the basement aquifer) is located at depths greater than 1,400 feet.

Ground Water Quality

Ground Water Classification. In accordance with UAC R317-6-3.5 and ground water quality data provided in the permit application which includes ground water monitored in nearby groundwater compliance wells, is classified as Class II Drinking Water Quality Ground Water. As required in Part II.H.3 of the permit, an accelerated background monitoring program will be completed by the permittee to collect data for calculating well-specific background ground water quality statistics. After securing Director approval of the Accelerated Background Monitoring Report, background concentrations may be adjusted in accordance with the reopener provision in Part V.N of the permit.

Class II Protection Levels. In accordance with UAC R317-6-4.5, Class II ground water will be protected for use as drinking water or other similar beneficial use with conventional treatment prior to use. Class II protection levels are established in accordance with the following criteria in UAC R317-6-4.2B:

- a. Total dissolved solids (TDS) may not exceed the greater of 1.25 times the background concentration or the background plus two standard deviations.
- b. When a contaminant is present in a detectable amount as a background concentration, the concentration of the pollutant may not exceed the greater of 1.25 times the background concentration, 0.25 times the ground water quality standard, or background plus two standard deviations; however, in no case will the concentration of a pollutant be allowed to exceed the ground water quality standard.
- c. When a contaminant is not present in a detectable amount as a background concentration, the concentration of the pollutant may not exceed the greater of 0.25 times the ground water quality standard, or the limit of detection.

COMPLIANCE SCHEDULE

- Cooling and Blowdown Water Pond Operating Manual/Standard Operating Plan. Pond monitoring, operation, maintenance, and repair procedures shall be described in the manual for Director review and approval before authorization to operate is granted. The Operating Manual will also describe the timeline for pond filling over several years and will develop pond level-specific leak rates for the filling schedule until the pond is operating at full design capacity. This will ensure that a leak that is below the manufacture-rated 8 gpm but above what should be expected at a lower fill level will be detected.

- Accelerated Background Monitoring Report. Newly installed ground water monitoring wells shall be sampled on a quarterly frequency for 8 consecutive quarters. Statistical calculations shall be presented in the report for the purposes of establishing ground water class protection levels in accordance with UAC R317-6-4.
- Final Closure Plan. In the event that the permittee decides to discontinue its operations at the facility the permittee shall notify the Director of such a decision and submit a Final Closure Plan within 180 days prior to the closure of the facility.

Permit Application Documents

The documents that comprise the Groundwater Discharge Permit Application (for ACES Cooling and Blowdown Water Pond) submitted under cover letter dated June 19, 2023 by ACES I, LLC and subsequent revisions are considered part of the administrative file for this permit.